



# Product Catalogue

*“Disposable Medical Solutions”*





# Table of Contents

■	About Us . . . . .	2
■	Mission and Vision . . . . .	3
■	Birth of Brand and Range of Products . . . . .	4
■	Why Disposable - A Quality Drape . . . . .	5
■	Certificates . . . . .	6
■	Surgical Gowns . . . . .	7
■	Surgical Drape Types . . . . .	13
■	General Surgery Drape Sets . . . . .	45
■	Surgical Drape Sets for Orthopedics . . . . .	51
■	Surgical Drape Sets for Cardiology . . . . .	59
■	Surgical Drape Sets for Gynecology . . . . .	64
■	Neurosurgical Drape Sets . . . . .	70
■	Ophthalmologic Surgical Drape Sets . . . . .	74
■	Surgical Drape Sets for Oncology . . . . .	79
■	Surgical Drape Sets for Urology . . . . .	81
■	Surgical Drape Sets for ENT . . . . .	86
■	Surgical Drape Sets for Aesthetics . . . . .	89
■	Dental Surgical Drape Sets . . . . .	92
■	Disposable Clothing and Equipment . . . . .	95

## About Us

**AKMEDA MEDIKAL**, which is active in the disposable medical textile production sector, successfully provides services in this sector. Our company, which carries out its activities on its factory established on a total area of 2000 m<sup>2</sup>; 1500 m<sup>2</sup> closed and 500 m<sup>2</sup> open area in Ankara Ostim Organized Industrial Zone, has a production capacity of 250.000 Disposable Drape Sets and 1.500.000 Disposable Gowns per year with the product brand of .



## AKMEDA MEDIKAL

Production Line of our Company

Fully Automatic Fabric Spreading Machine with 240 cm table width

Fully Automatic Fabric Cutting Machine with 240 cm table width

Ultrasonic Sewing Machines

Overlock Machines Conventional Sewing Machines

ETO Sterilization Machines with a 15.000 lt. capacity

Clean Room in compliance with Class 100.000 Standard

## Mission;

To meet the customer demand and expectations at the highest level by continuously improving the product and service quality

To be among the innovative, internationally accepted brands that create value for human health

To make customer satisfaction, belonging and loyalty sustainable

To produce the “first” and the “best” ones in the field of disposable medical textile products by developing new products

To provide product support to its customers during sales and after-sales process



## Vision;

Our vision is to make  a world brand by offering the same quality service to all its customers without compromising its health and hygiene policy,

by regards human resource as the most valuable asset,

by constantly improving their methods in the field of expertise in order to improve productivity,

by creating its own brand,

by increasing its service quality in its field as a reliable and reputable company, and

by presenting hygienic products to the users.

## Birth of Our Brand

Our company, which has started out with the aim of creating a world brand, has created  brand by inspiring from the names of two main sectors in which it is active as a result of the permanent identification studies in this long run.

With a simple name preference, our company wishes to emphasize with a simple expression that it would be a long-running actor and has a full command of the essence of work in the Disposable Surgical Products field.

At this point, we see that  brand has a voice and also has become a determinant brand.

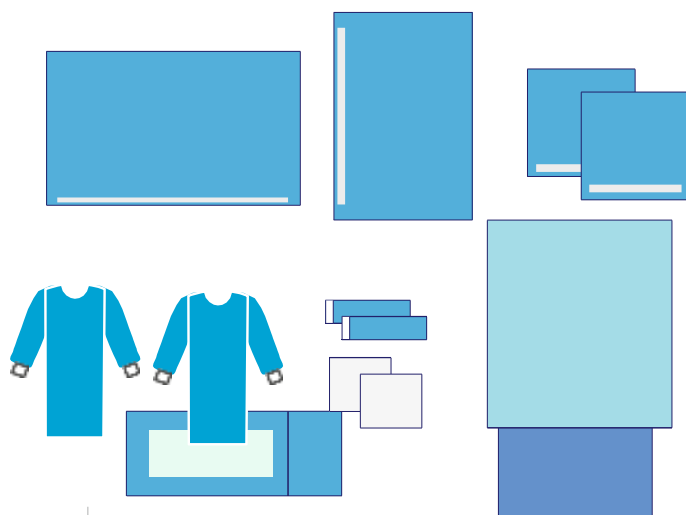

The followings are produced together with



Disposable Drape Sets (Sterile & Non-Sterile) specific to all surgical operations,

Disposable Apron Types (Sterile & Non-Sterile) specific to all surgical operation team,

Disposable Lab Coats,

Disposable Clothes and Gowns,

Disposable Work-clothing,

Disposable Medical Device Cases, and

Human Remains Pouches

## Why disposable;

The general objective of the drapes used in the surgical operations is to serve as a barrier against bacteria being a factor in the development of surgical site infections. In this way; the sterile site can maintain its sustainability because the material used is disposable and also minimize the infection risk. Its feature being specific to the operations and person increases extraordinarily the sustainability of the sterile site.



## A Quality Drape;

It should be in accordance with the operating room environment and operation dynamics.

It should maintain the pre-set body temperature.

It should have an acceptable resistance to mechanical electrification and ignition.

It should be resistant to wear, tear, and the most importantly to puncture.

It should be resistant to bacterial permeability.

It should be sterilized and also should sustain this status.

It should be antitoxic.

It should be anti-pilling and also should not release dust.

It should be of fine-porous and ticking in terms of weaving structure.









Medicotex

Surgical Gowns



### Standard Surgical Gowns

These Gowns can be produced from SMS / SMMMS / Biflex / Spunlace / Triplex fabrics upon request. The sleeves are connected with ultrasonic sewing which provides high quality.

It is impermeable to liquid and also resistant to wear and tear. The cotton rib cuffs are used on the sleeve hems. It offers high comfort and comfortable working opportunities. It is unreinforced.

Depending on the sterilization preference, the Ethylene Oxide or Gamma Sterilization can be done. The product meets EN 13795 Standard and high performance values.

Size	Sterile	Units per Package	Non-Sterile	Units per Package
S	MDC-ONL-0011	40	NS-ONL-011	40
M	MDC-ONL-0012	40	NS-ONL-012	40
L	MDC-ONL-0013	40	NS-ONL-013	40
XL	MDC-ONL-0014	40	NS-ONL-014	40
XXL	MDC-ONL-0015	40	NS-ONL-015	40

Size	Sterile	Units per Package	Non-Sterile	Units per Package
L, Extra Long	MDC-ONL-0064	40	NS-ONL-016	40
XL, Extra Long	MDC-ONL-0065	40	NS-ONL-017	40
XXL, Extra Long	MDC-ONL-0066	40	NS-ONL-018	40

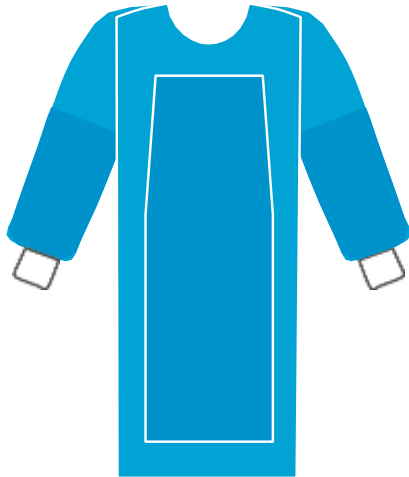

**Reinforced Surgical Gowns**

These Gowns can be produced from SMS / SMMMS / Biflex / Spunlace / Triplex fabrics upon request. The sleeves are connected with ultrasonic sewing which provides high quality.

It is impermeable to liquid and also resistant to wear and tear. The cotton rib cuffs are used on the sleeve hems. It offers high comfort and comfortable working opportunities. Its sleeves and body parts are reinforced. Depending on the sterilization preference, the Ethylene Oxide or Gamma Sterilization can be done. The product meets EN 13795 Standard and high performance values.

Size	Sterile	Units per Package	Non-Sterile	Units per Package
S	MDC-ONL-006	40	NS-ONL-019	40
M	MDC-ONL-007	40	NS-ONL-020	40
L	MDC-ONL-008	40	NS-ONL-021	40
XL	MDC-ONL-009	40	NS-ONL-022	40
XXL	MDC-ONL-010	40	NS-ONL-023	40

Size	Sterile	Units per Package	Non-Sterile	Units per Package
L, Extra Long	MDC-ONL-017	40	NS-ONL-024	40
XL, Extra Long	MDC-ONL-018	40	NS-ONL-025	40
XXL, Extra Long	MDC-ONL-019	40	NS-ONL-026	40

## Surgical Gowns



### Full-Reinforced Surgical Gowns

These Gowns can be produced from SMS / SMMMS / Biflex / Spunlace / Triplex fabrics upon request. The sleeves are connected with ultrasonic sewing which provides high quality.

It is impermeable to liquid and also resistant to wear and tear. The cotton rib cuffs are used on the sleeve hems. It offers high comfort and comfortable working opportunities. Its all parts are reinforced. Depending on the sterilization preference, the Ethylene Oxide or Gamma Sterilization can be done. The product meets EN 13795 Standard and high performance values.

Size	Sterile	Units per Package	Non-Sterile	Units per Package
S	MDC-ONL-001	40	NS-ONL-027	40
M	MDC-ONL-002	40	NS-ONL-028	40
L	MDC-ONL-003	40	NS-ONL-029	40
XL	MDC-ONL-004	40	NS-ONL-030	40
XXL	MDC-ONL-005	40	NS-ONL-031	40

Size	Sterile	Units per Package	Non-Sterile	Units per Package
L, Extra Long	MDC-ONL-026	40	NS-ONL-032	40
XL, Extra Long	MDC-ONL-027	40	NS-ONL-033	40
XXL, Extra Long	MDC-ONL-028	40	NS-ONL-034	40



**Chemotherapy Gown**

These Gowns can be produced from SMS / SMMMS / Biflex / Spunlace / Triplex fabrics upon request. The sleeves are connected with ultrasonic sewing which provides high quality.

It is impermeable to liquid and also resistant to wear and tear. The cotton rib cuffs are used on the sleeve hems. It offers high comfort and comfortable working opportunities. Its sleeves and body parts are reinforced. Depending on the sterilization preference, the Ethylene Oxide or Gamma Sterilization can be done. The product meets EN 13795 Standard and high performance values.

Size	Sterile	Units per Package	Non-Sterile	Units per Package
S	MDC-ONL-0102	40	NS-ONL-035	40
M	MDC-ONL-0103	40	NS-ONL-036	40
L	MDC-ONL-0104	40	NS-ONL-037	40
XL	MDC-ONL-0105	40	NS-ONL-038	40
XXL	MDC-ONL-0106	40	NS-ONL-039	40

## Surgical Gowns

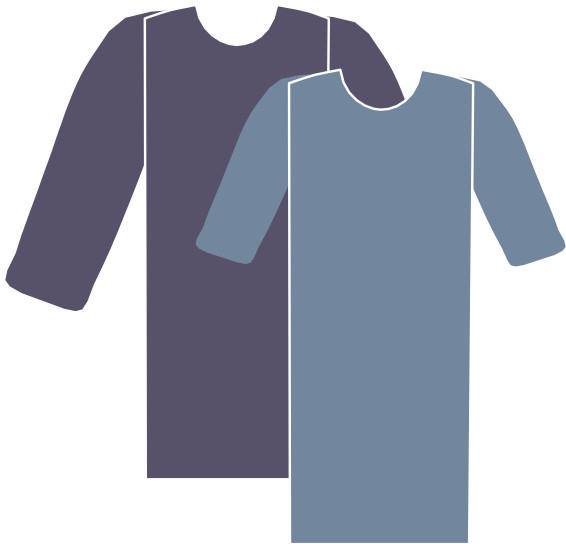

### Visitor Gowns

These gowns can be produced from spun bond fabric in the range of 35 - 65 gsm upon request. The sleeves are connected from the shoulders with ultrasonic sewing which provides high quality. They can be produced as short and long-sleeved upon request.

Size	Non-Sterile	Units per Package
S	NS-ONL-001	40
M	NS-ONL-002	40
L	NS-ONL-003	40
XL	NS-ONL-004	40
XXL	NS-ONL-005	40

Size	Non-Sterile	Units per Package
S (short-sleeved)	NS-ONL-006	40
M (short-sleeved)	NS-ONL-007	40
L (long-sleeved)	NS-ONL-008	40
XL (short-sleeved)	NS-ONL-009	40
XXL (short-sleeved)	NS-ONL-010	40





## Surgical Drape Types



## TOOLS TABLE DRAPES

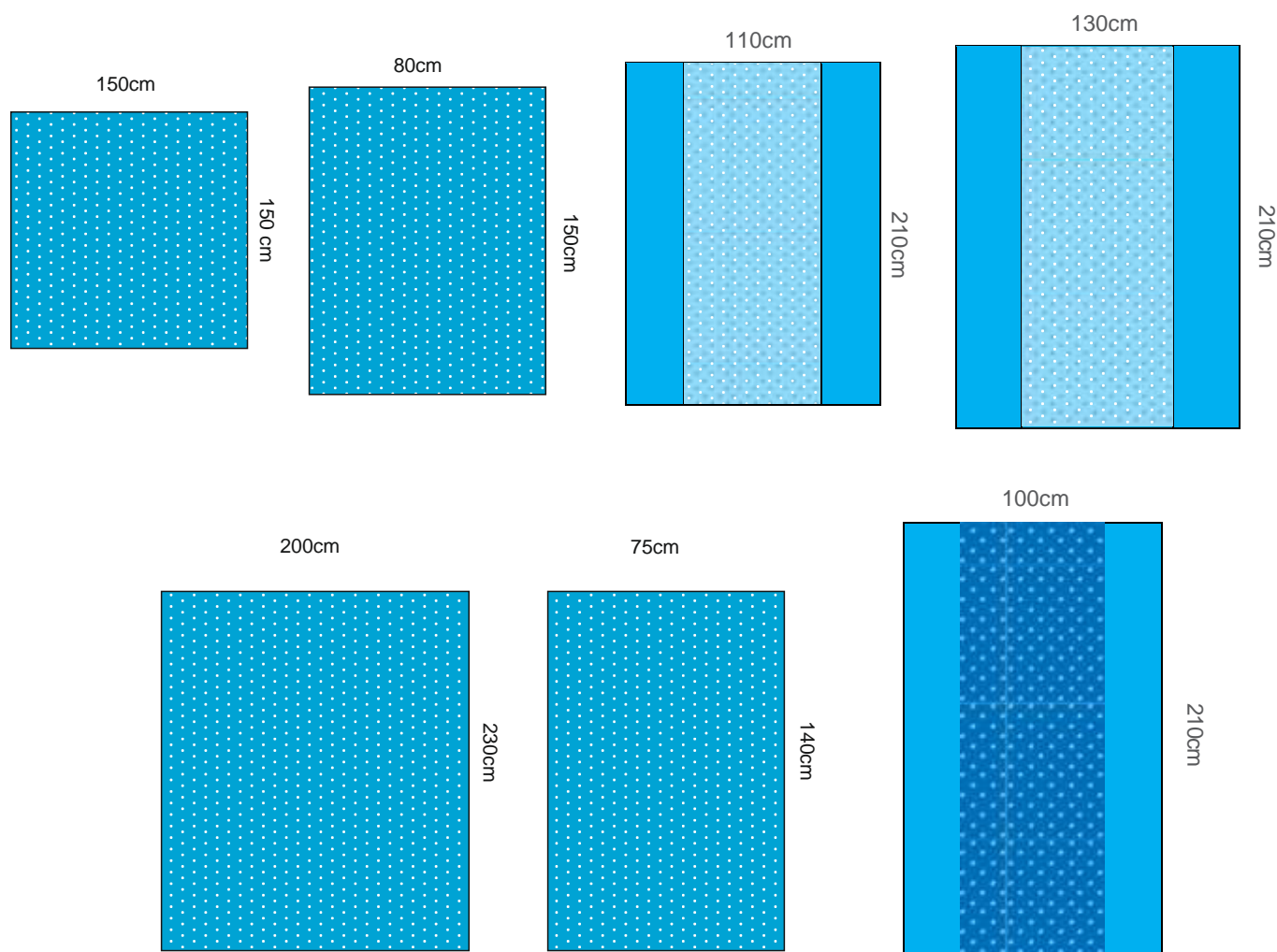

Sizes	Sterile	Units per Package	Non-Sterile	Units per Package
150 X 150 cm	MDC-ORT-00050	40	NS-ORT-00050	40
80 X 150 cm	MDC-ORT-00030	40	NS-ORT-00030	40
110 X 210 cm	MDC-ORT-00072	40	NS-ORT-02160	40
130 X 210 cm	MDC-ORT-00015	40	NS-ORT-02174	40
200 X 230 cm	MDC-ORT-00030	40	NS-ORT-00072	40
75 X 140 cm	MDC-ORT-00072	40	NS-ORT-00015	40
100 X 210 cm	MDC-ORT-00015	40	NS-ORT-02153	40

*Note: The drape sizes are for information purposes. It can be produced in any desired sizes and fabric types.*

## Drapes for Mayo Stand

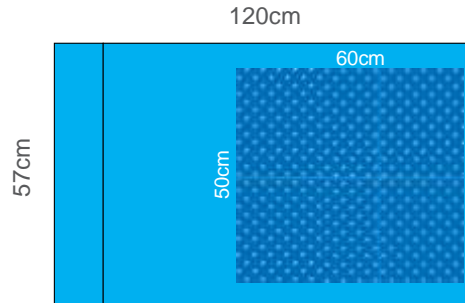
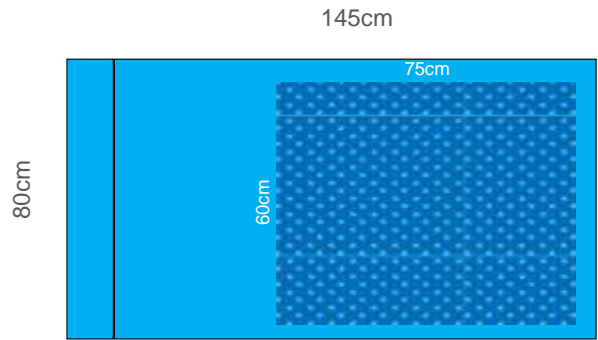
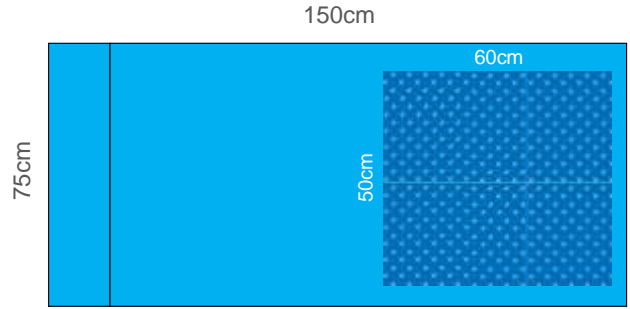
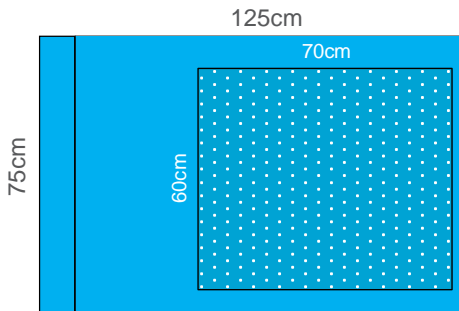
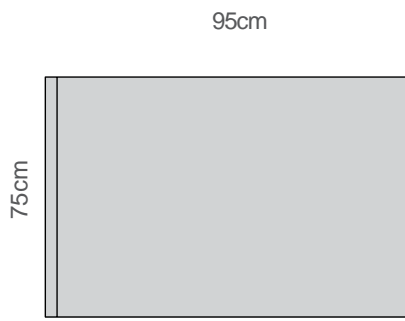
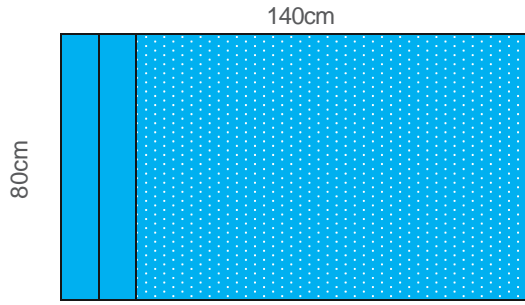
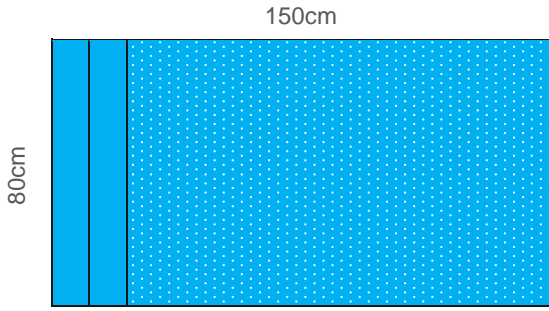

Sizes	Sterile	Units per Package	Non-Sterile	Units per Package
80 X 150 cm	MDC-ORT-00102	40	NS-ORT-00102	40
80 X 140 cm	MDC-ORT-00100	40	NS-ORT-00100	40
75 X 95 cm	MDC-ORT-00078	40	NS-ORT-00078	40
75 X 125 cm	MDC-ORT-00084	40	NS-ORT-00084	40
75 X 150 cm	MDC-ORT-00089	40	NS-ORT-00089	40
80 X 145 cm	MDC-ORT-00101	40	NS-ORT-00101	40
57 X 120 cm	MDC-ORT-00074	40	NS-ORT-00074	40

Not: Örtü

Note: The drape sizes are for information purposes. It can be produced in any desired sizes and fabric types.



## Plain Drapes

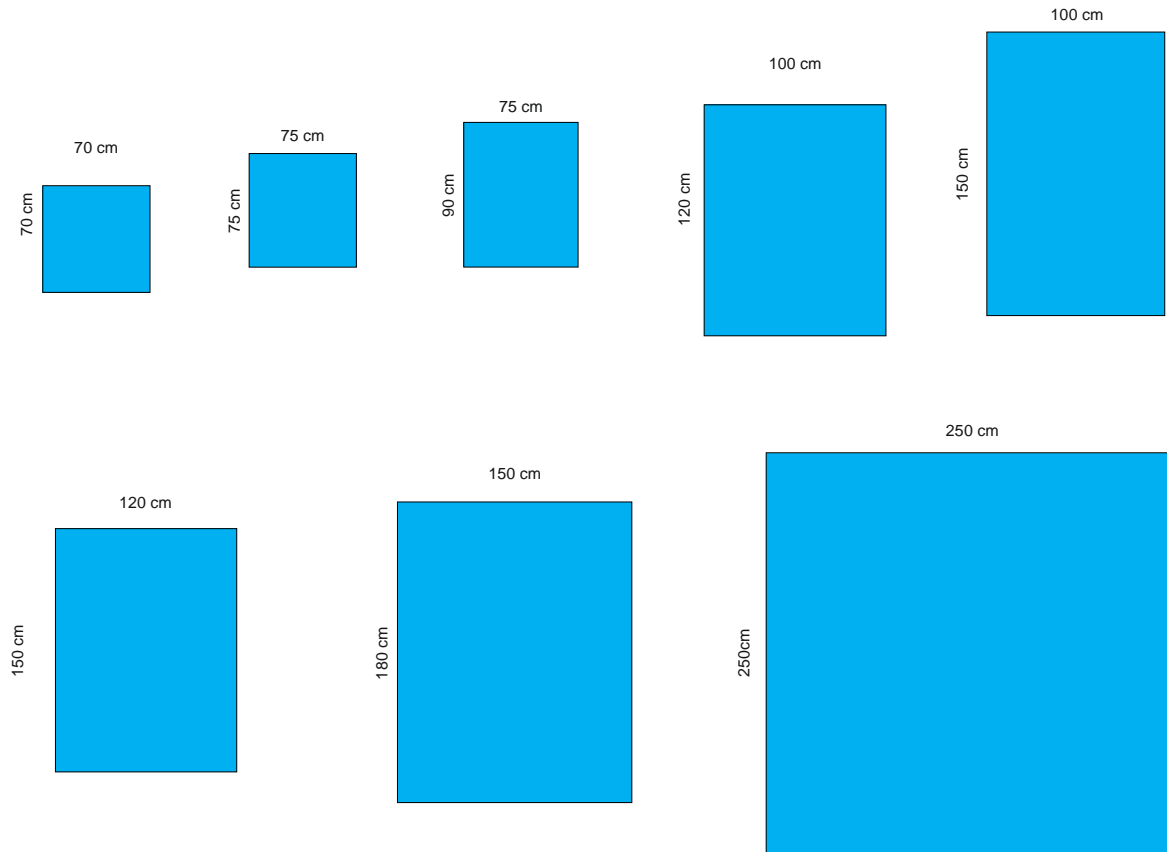

Sizes	Sterile	Units per Package	Non-Sterile	Units per Package
70 X 70 cm	MDC-ORT-02578	40	NS-ORT-02578	40
75 X 75 cm	MDC-ORT-02615	40	NS-ORT-02615	40
75 X 90 cm	MDC-ORT-02618	40	NS-ORT-02618	40
100 X 120 cm	MDC-ORT-02789	40	NS-ORT-02789	40
100 X 150 cm	MDC-ORT-02795	40	NS-ORT-02795	40
120 X 150 cm	MDC-ORT-02909	40	NS-ORT-02909	40
150 X 180 cm	MDC-ORT-03056	40	NS-ORT-03056	40
250 X 250 cm	MDC-ORT-03297	40	NS-ORT-03297	40

*Note: The drape sizes are for information purposes. It can be produced in any desired sizes and fabric types*

## Side Taped Drapes

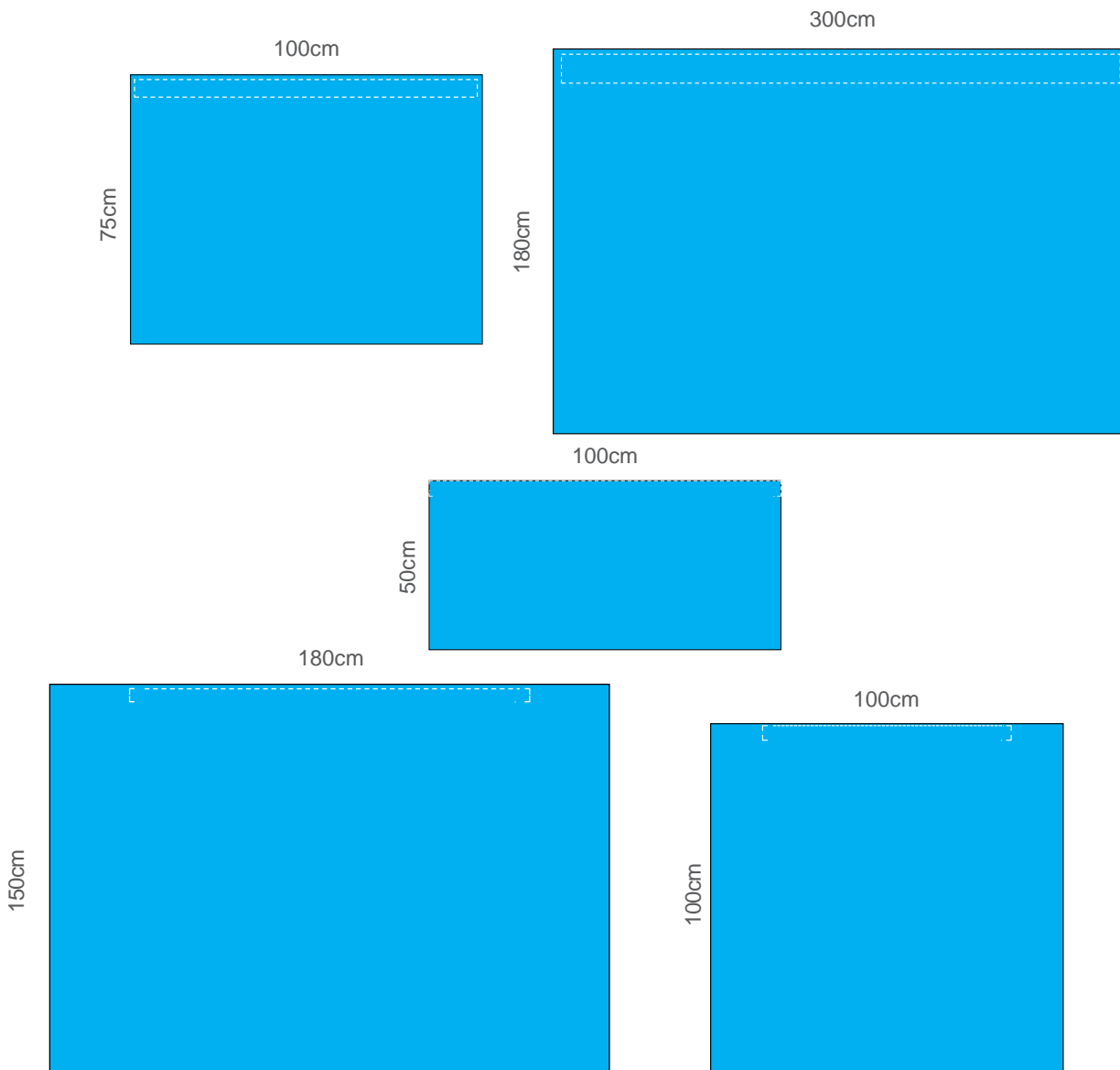

Sizes	Sterile	Units per Package	Non-Sterile	Units per Package
75 X 100 cm	MDC-ORT-07516	40	NS-ORT-07516	40
180 X 300 cm	MDC-ORT-07534	40	NS-ORT-07534	40
50 X 100 cm	MDC-ORT-07508	40	NS-ORT-07508	40
150 X 180 cm	MDC-ORT-07530	40	NS-ORT-07530	40
100 X 100 cm	MDC-ORT-07527	40	NS-ORT-07527	40

*Note: The drape sizes are for information purposes. It can be produced in any desired sizes and fabric types.*



## Abdominal Drapes

200cm

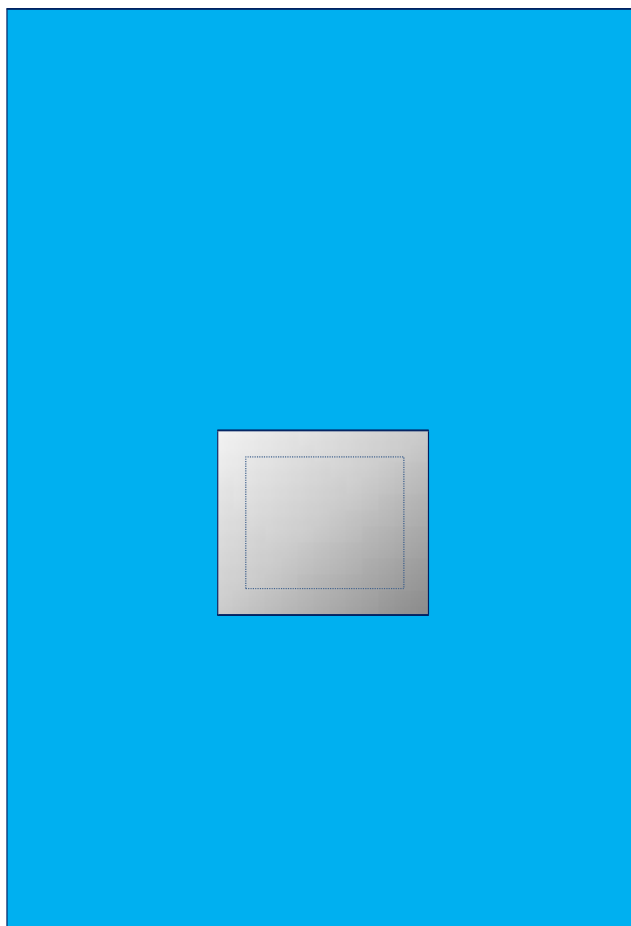

Sizes	Sterile	Units per Package	Non-Sterile	Units per Package
200 X 320 cm	MDC-ORT-08589	40	NS-ORT-08589	40

*Note: The drape sizes are for information purposes. It can be produced in any desired sizes and fabric types.*

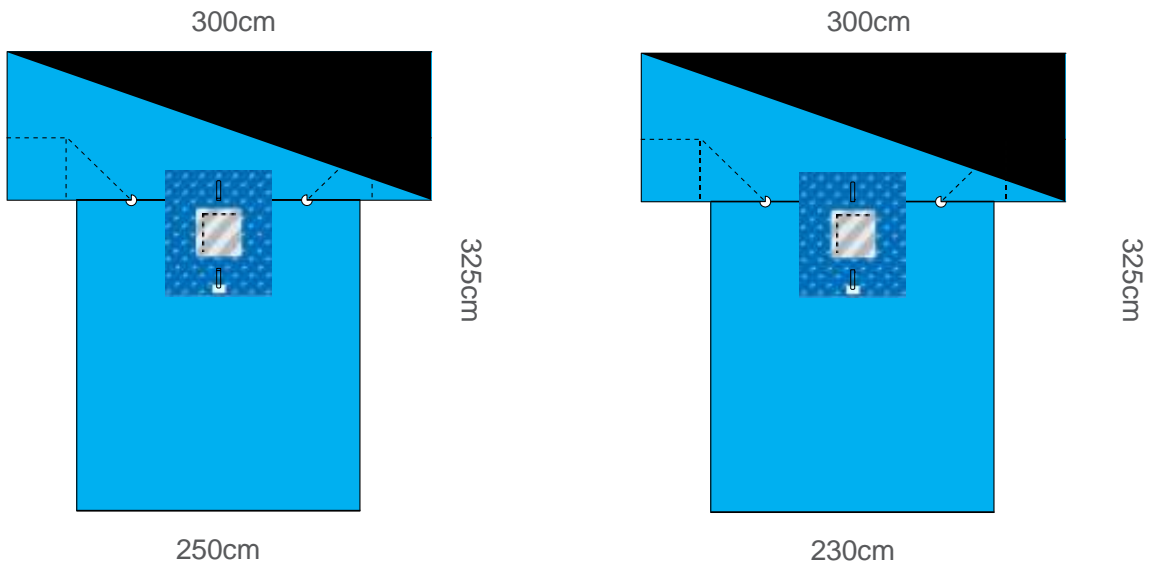

Sizes	Sterile	Units per Package	Non-Sterile	Units per Package
250 X 325 X 300 cm	MDC-ORT-08590	40	NS-ORT-08590	40
230 X 325 X 300 cm	MDC-ORT-08591	40	NS-ORT-08591	40

*Note: The drape sizes are for information purposes. It can be produced in any desired sizes and fabric types.*

## Laparoscopy Drape

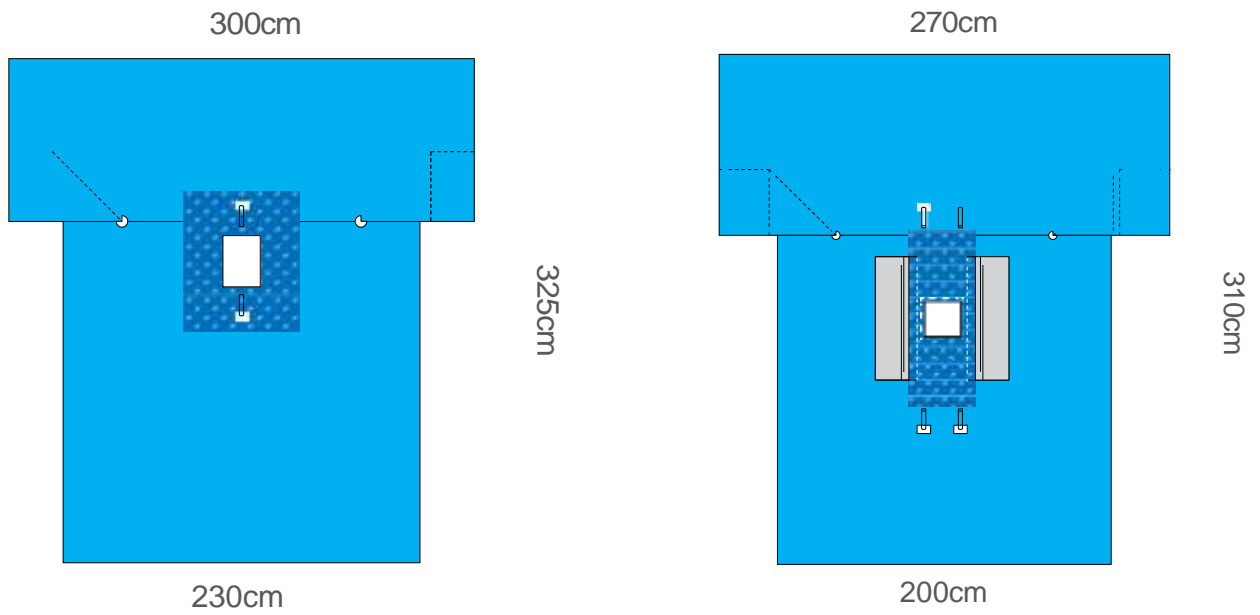

Sizes	Sterile	Units per Package	Non-Sterile	Units per Package
230 X 325 X 300 cm	MDC-ORT-08592	40	NS-ORT-08592	40
200 X 310 X 270 cm	MDC-ORT-08593	40	NS-ORT-08593	40

*Note: The drape sizes are for information purposes. It can be produced in any desired sizes and fabric types.*

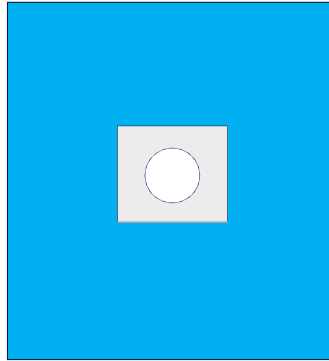

Sizes	Sterile	Units per Package	Non-Sterile	Units per Package
30 X 30 cm	MDC-ORT-05402	40	NS-ORT-05402	40
40 X 250 cm	MDC-ORT-05533	40	NS-ORT-05533	40
50 X 50 cm	MDC-ORT-05576	40	NS-ORT-05576	40
100 X 100 cm	MDC-ORT-05941	40	NS-ORT-05941	40
100 X 150 cm	MDC-ORT-05951	40	NS-ORT-05951	40
150 X 240 cm	MDC-ORT-06224	40	NS-ORT-06224	40
250 X 250 cm	MDC-ORT-06453	40	NS-ORT-06453	40

*Note: The drape sizes are for information purposes. It can be produced in any desired sizes and fabric types.*

## Fenestrated Drape

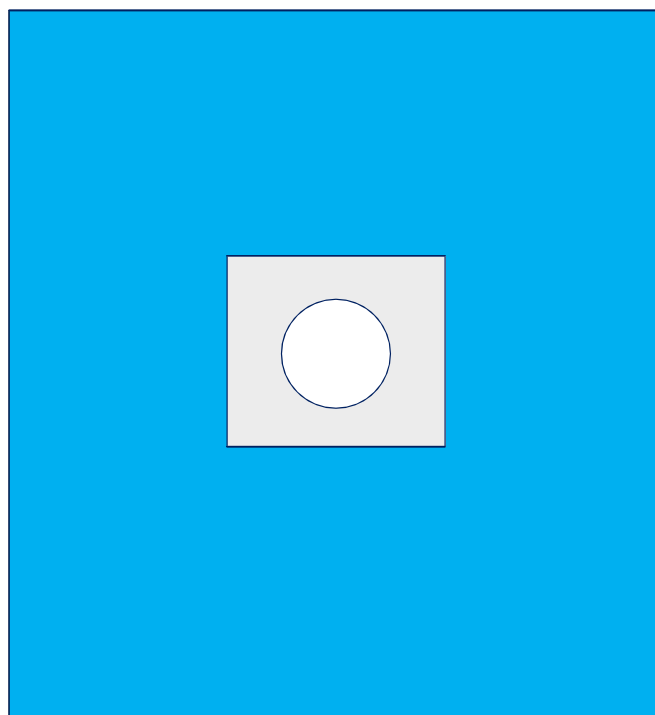

Sizes	Sterile	Units per Package	Non-Sterile	Units per Package
105 X 175 cm	MDC-ORT-03882	40	NS-ORT-03882	40
115 X 245 cm	MDC-ORT-03953	40	NS-ORT-03953	40
130 X 230 cm	MDC-ORT-04028	40	NS-ORT-04028	40
150 X 235 cm	MDC-ORT-04119	40	NS-ORT-04119	40
170 X 250 cm	MDC-ORT-04196	40	NS-ORT-04196	40
185 X 250 cm	MDC-ORT-04241	40	NS-ORT-04241	40
250 X 250 cm	MDC-ORT-04349	40	NS-ORT-04349	40

*Note: The drape sizes are for information purposes. It can be produced in any desired sizes and fabric types.*

200cm

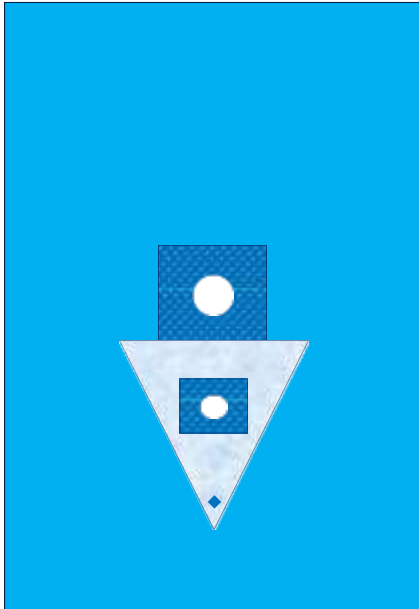

300cm

230cm

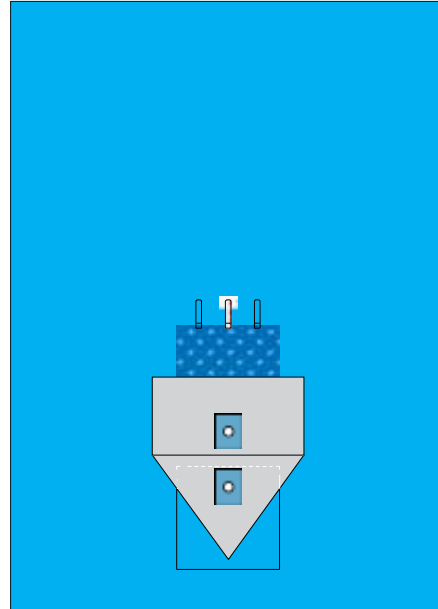

400cm

Sizes	Sterile	Units per Package	Non-Sterile	Units per Package
200 X 300 cm	MDC-ORT-08594	40	NS-ORT-08594	40
230 X 400 cm	MDC-ORT-08595	40	NS-ORT-08595	40

*Note: The drape sizes are for information purposes. It can be produced in any desired sizes and fabric types.*



## Extremity Drapes

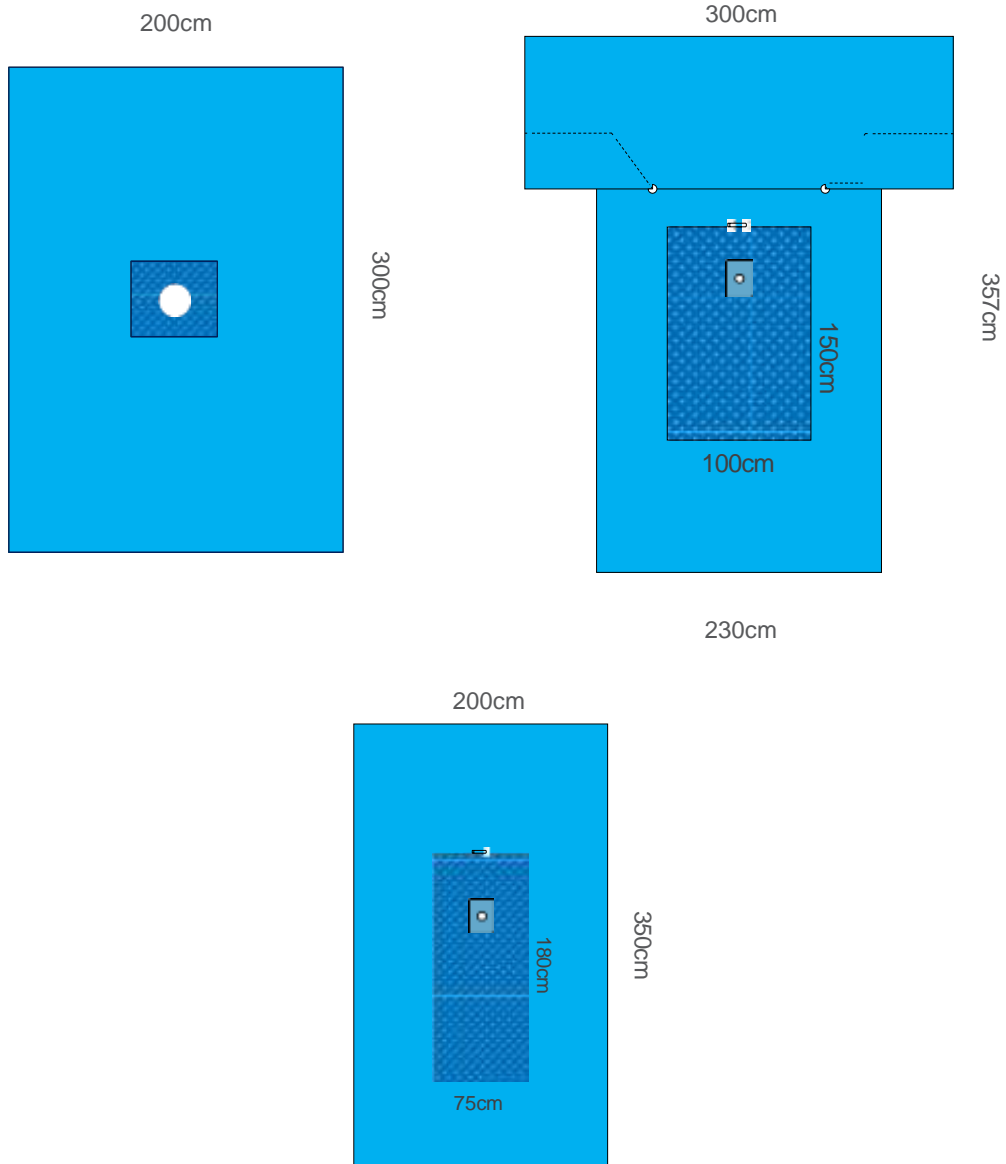

Sizes	Sterile	Units per Package	Non-Sterile	Units per Package
200 X 300 cm	MDC-ORT-08596	40	NS-ORT-08596	40
200 X 350 cm	MDC-ORT-08597	40	NS-ORT-08597	40
200 X 357 X 300 cm	MDC-ORT-08598	40	NS-ORT-08598	40

*Note: The drape sizes are for information purposes. It can be produced in any desired sizes and fabric types.*

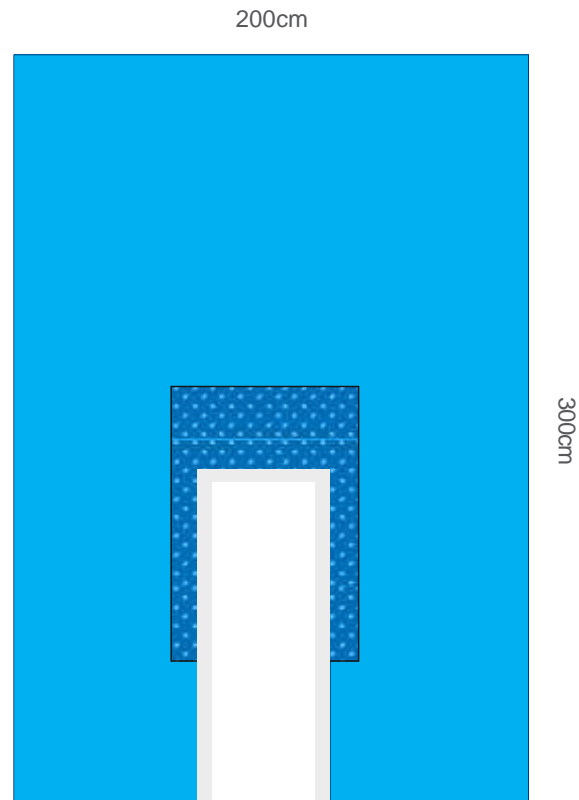

Sizes	Sterile	Units per Package	Non-Sterile	Units per Package
200 X 300 cm	MDC-ORT-08599	40	NS-ORT-08599	40

*Note: The drape sizes are for information purposes. It can be produced in any desired sizes and fabric types.*

## Hip Drape

200cm

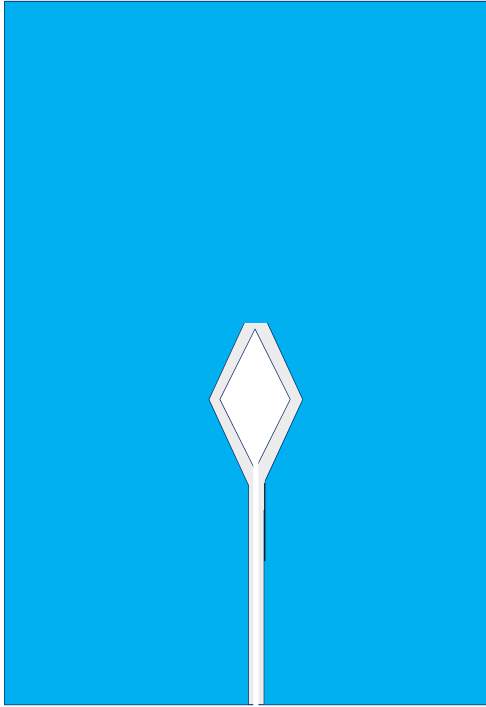

200cm

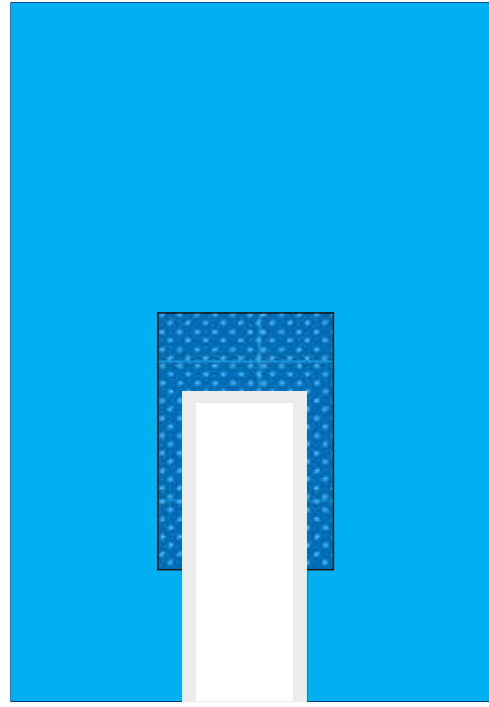

Sizes	Sterile	Units per Package	Non-Sterile	Units per Package
200 X 250 cm	MDC-ORT-08600	40	NS-ORT-08600	40
200 X 300 cm	MDC-ORT-08601	40	NS-ORT-08601	40

*Note: The drape sizes are for information purposes. It can be produced in any desired sizes and fabric types.*

## Angiography Drape

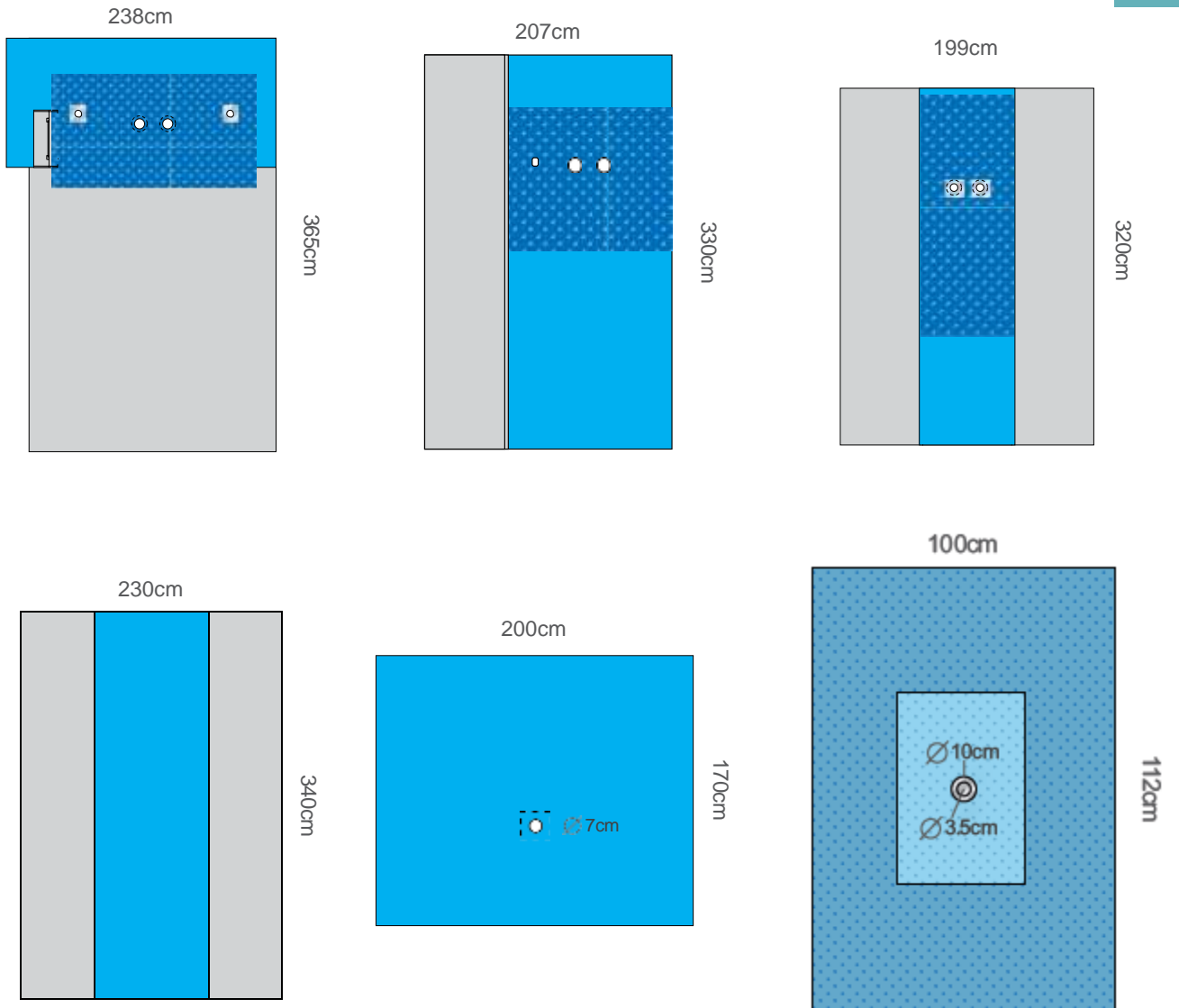

Sizes	Sterile	Units per Package	Non-Sterile	Units per Package
238 X 365 cm	MDC-ORT-08602	40	NS-ORT-08602	40
207 X 330 cm	MDC-ORT-08603	40	NS-ORT-08603	40
199 X 320 cm	MDC-ORT-08604	40	NS-ORT-08604	40
230 X 340 cm	MDC-ORT-08605	40	NS-ORT-08605	40
170 X 200 cm	MDC-ORT-08606	40	NS-ORT-08606	40
100 X 112 cm	MDC-ORT-08607	40	NS-ORT-08607	40

Note: The drape sizes are for information purposes. It can be produced in any desired sizes and fabric types.

## Cardiovascular Drapes

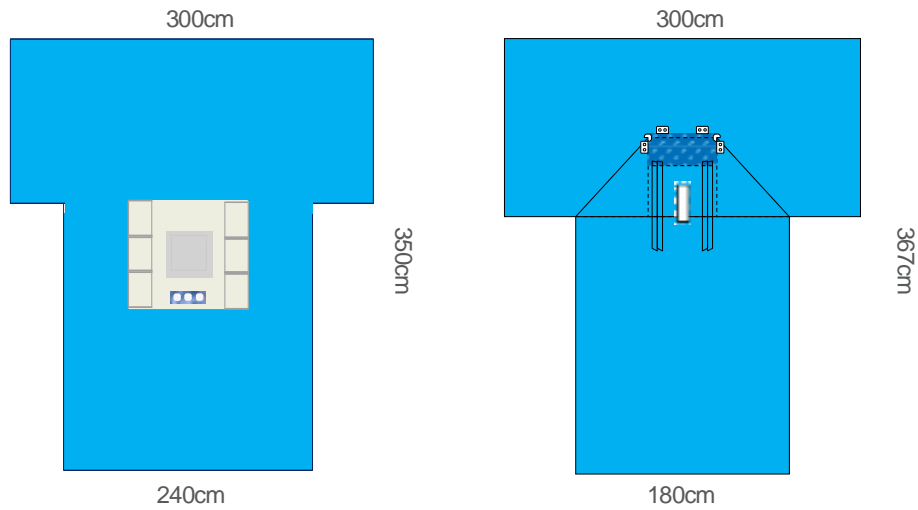

Sizes	Sterile	Units per Package	Non-Sterile	Units per Package
240 X 350 X 300 cm	MDC-ORT-08608	40	NS-ORT-08608	40
180 X 367 X 300 cm	MDC-ORT-08609	40	NS-ORT-08609	40

*Note: The drape sizes are for information purposes. It can be produced in any desired sizes and fabric types.*

Perineal U-Shaped Drapes

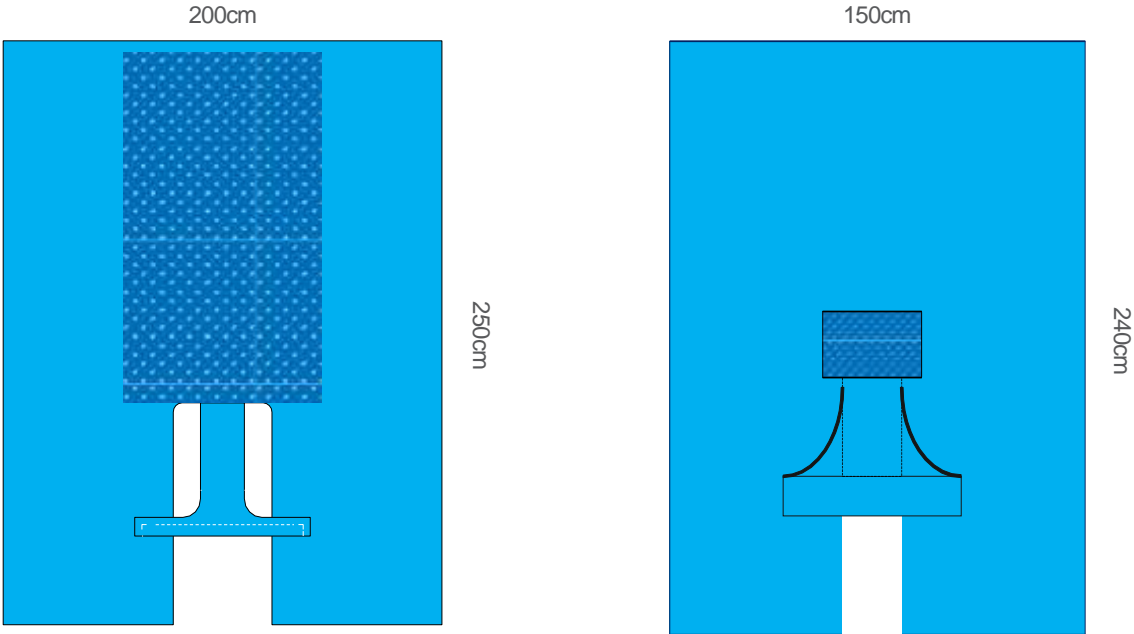

Sizes	Sterile	Units per Package	Non-Sterile	Units per Package
200 X 250 cm	MDC-ORT-08610	40	NS-ORT-08610	40
150 X 240 cm	MDC-ORT-08611	40	NS-ORT-08611	40

*Note: The drape sizes are for information purposes. It can be produced in any desired sizes and fabric types.*

Embryo Transfer Drape

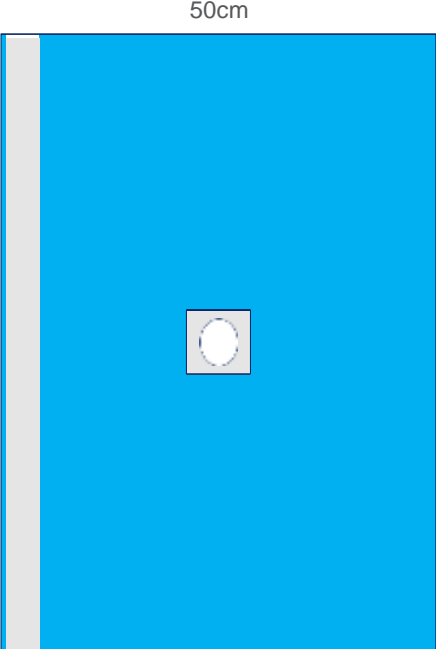

Sizes	Sterile	Units per Package	Non-Sterile	Units per Package
50 X 90 cm	MDC-ORT-08612	40	NS-ORT-08612	40

Note: The drape sizes are for information purposes. It can be produced in any desired sizes and fabric types.

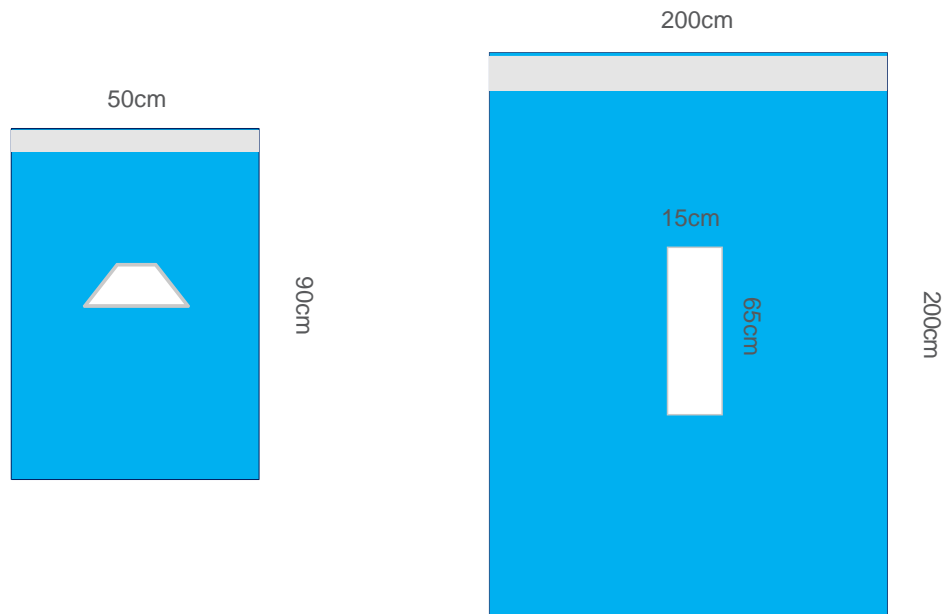

Sizes	Sterile	Units per Package	Non-Sterile	Units per Package
50 X 90 cm	MDC-ORT-08613	40	NS-ORT-08613	40
200 X 200 cm	MDC-ORT-08614	40	NS-ORT-08614	40

*Note: The drape sizes are for information purposes. It can be produced in any desired sizes and fabric types.*



## Cesarean Drapes

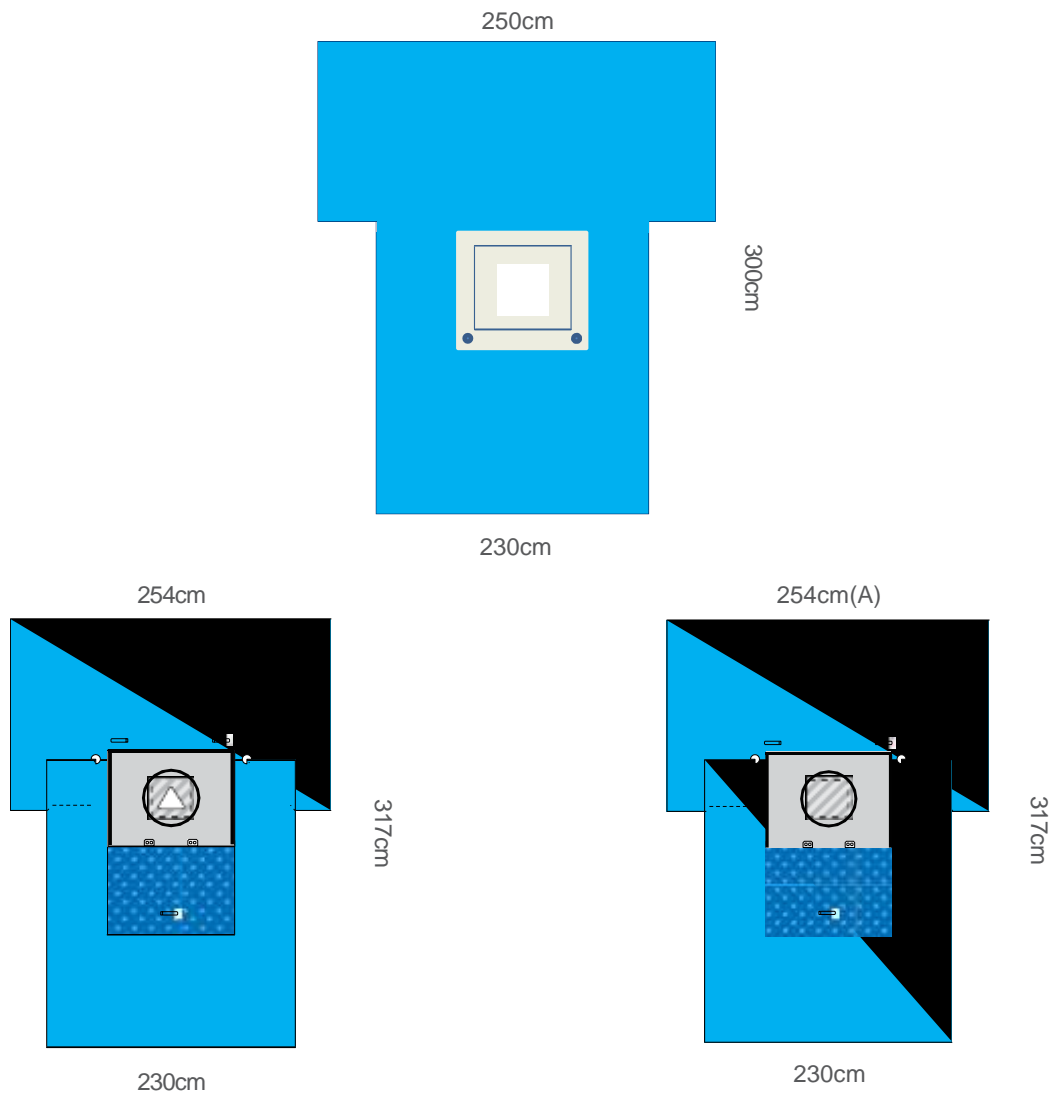

Sizes	Sterile	Units per Package	Non-Sterile	Units per Package
230 X 300 X 250 cm	MDC-ORT-08615	40	NS-ORT-08615	40
230 X 317 X 254 cm	MDC-ORT-08616	40	NS-ORT-08616	40
230X317X254cm(A)	MDC-ORT-08617	40	NS-ORT-08617	40

*Note: The drape sizes are for information purposes. It can be produced in any desired sizes and fabric types.*

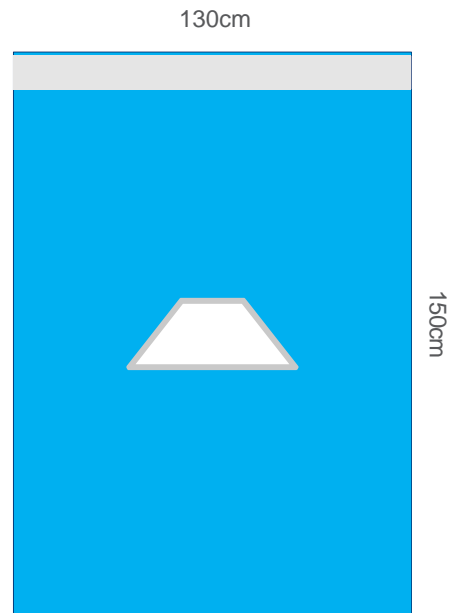

Sizes	Sterile	Units per Package	Non-Sterile	Units per Package
130 X 150 cm	MDC-ORT-08618	40	NS-ORT-08618	40

*Note: The drape sizes are for information purposes. It can be produced in any desired sizes and fabric types.*

## Craniotomy Drapes

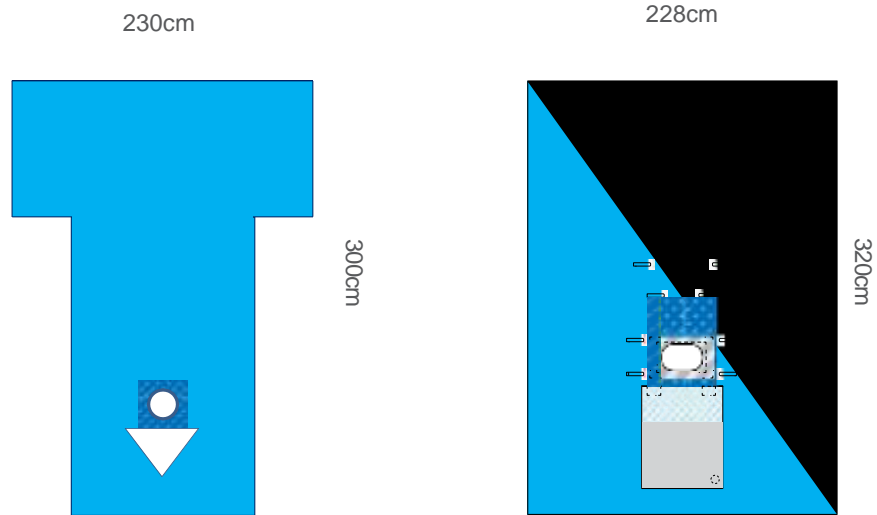

Sizes	Sterile	Units per Package	Non-Sterile	Units per Package
230 X 300 cm	MDC-ORT-08619	40	NS-ORT-08619	40
228 X 320 cm	MDC-ORT-08620	40	NS-ORT-08620	40

*Note: The drape sizes are for information purposes. It can be produced in any desired sizes and fabric types.*

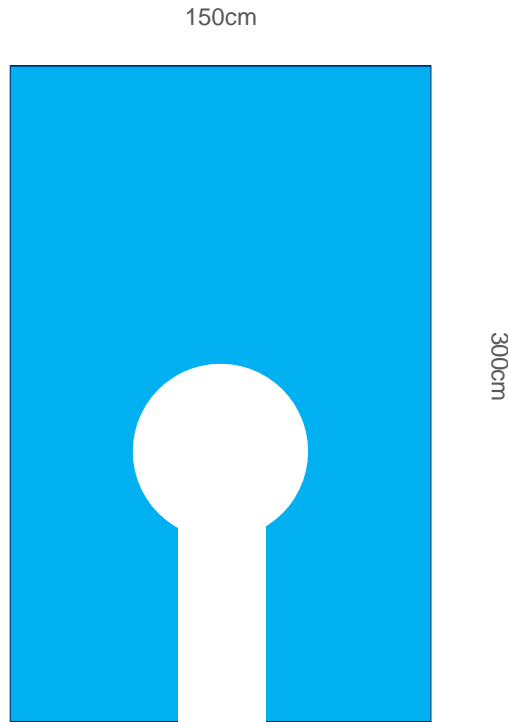

Sizes	Sterile	Units per Package	Non-Sterile	Units per Package
150 X 300 cm	MDC-ORT-08621	40	NS-ORT-08621	40

*Note: The drape sizes are for information purposes. It can be produced in any desired sizes and fabric types.*

## Spinal Drapes

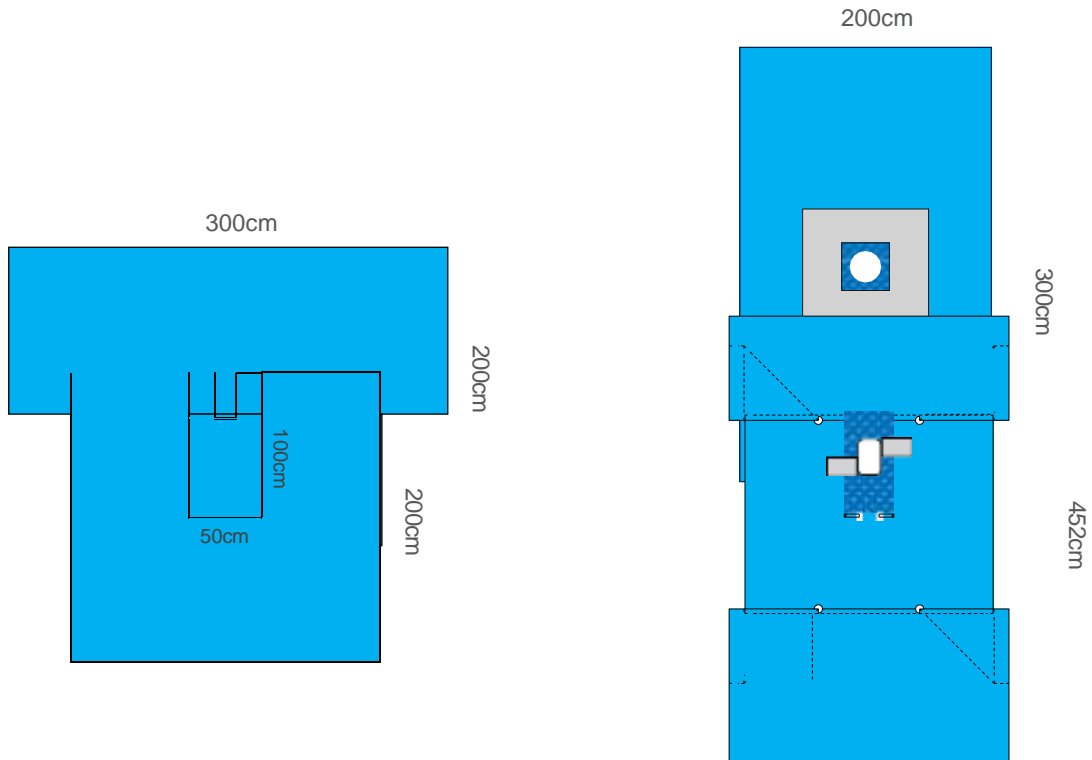

Sizes	Sterile	Units per Package	Non-Sterile	Units per Package
210 X 200 X 300 cm	MDC-ORT-08622	40	NS-ORT-08622	40
200 X 210 cm	MDC-ORT-08623	40	NS-ORT-08623	40
200 X 300 cm	MDC-ORT-08624	40	NS-ORT-08624	40
282 X 452 cm	MDC-ORT-08625	40	NS-ORT-08625	40

*Note: The drape sizes are for information purposes. It can be produced in any desired sizes and fabric types.*

## Eye Drapes

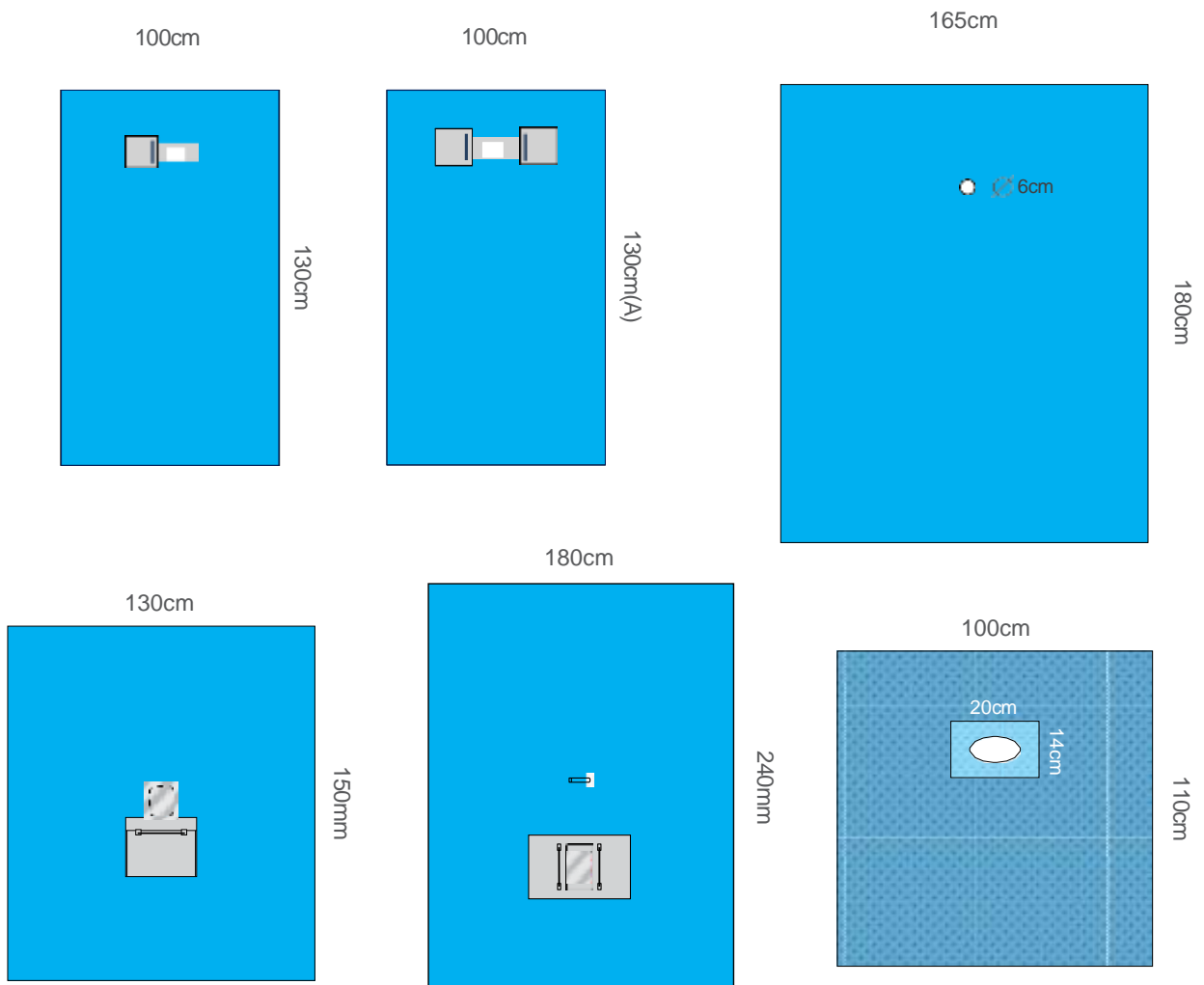

Sizes	Sterile	Units per Package	Non-Sterile	Units per Package
100 X 130 cm	MDC-ORT-08626	40	NS-ORT-08626	40
100X 130(A) cm	MDC-ORT-08627	40	NS-ORT-08627	40
165 X 180 cm	MDC-ORT-08628	40	NS-ORT-08628	40
130 X 150 cm	MDC-ORT-08629	40	NS-ORT-08629	40
180 X 240 cm	MDC-ORT-08630	40	NS-ORT-08630	40
100 X 110 cm	MDC-ORT-08631	40	NS-ORT-08631	40

*Note: The drape sizes are for information purposes. It can be produced in any desired sizes and fabric types.*

## Percutaneous Drape

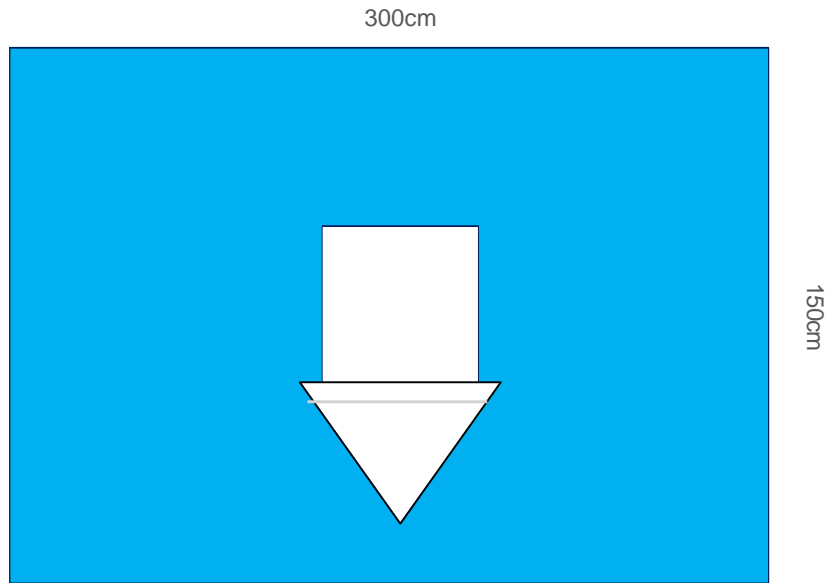

Sizes	Sterile	Units per Package	Non-Sterile	Units per Package
150 X 300 cm	MDC-ORT-08632	40	NS-ORT-08632	40

*Note: The drape sizes are for information purposes. It can be produced in any desired sizes and fabric types.*

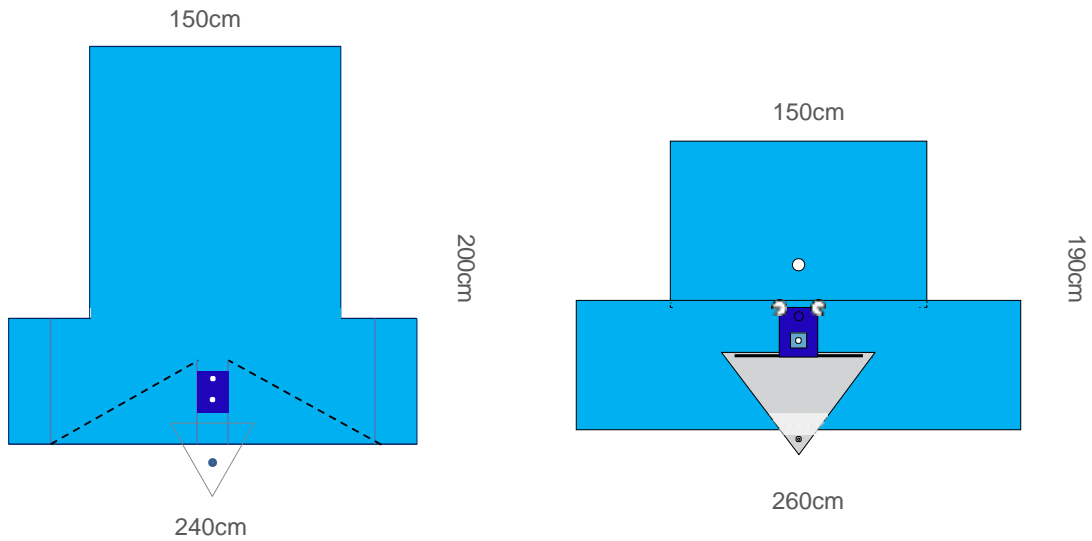

Sizes	Sterile	Units per Package	Non-Sterile	Units per Package
240 X 200 X 150 cm	MDC-ORT-08633	40	NS-ORT-08633	40
260 X 190 X 150 cm	MDC-ORT-08634	40	NS-ORT-08634	40

*Note: The drape sizes are for information purposes. It can be produced in any desired sizes and fabric types.*



## Cystoscopy Drapes

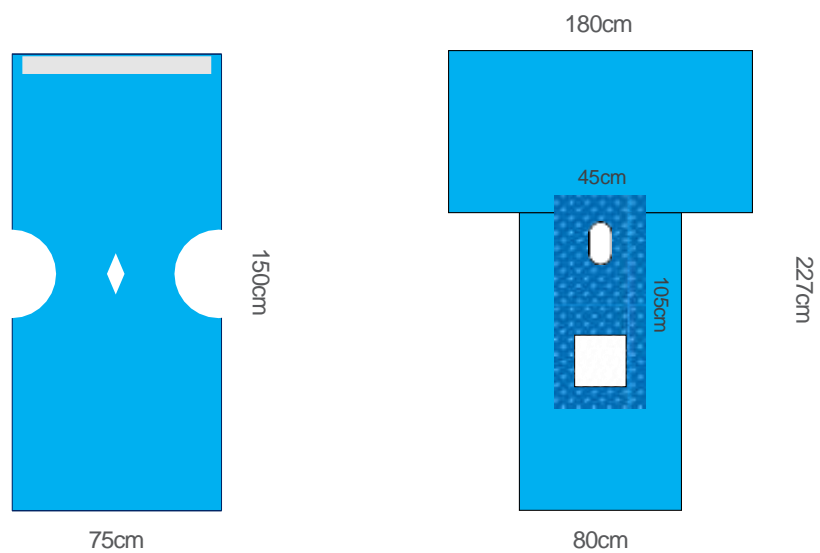

Sizes	Sterile	Units per Package	Non-Sterile	Units per Package
75 X 150 cm	MDC-ORT-08635	40	NS-ORT-08635	40
80 X 227 X 180 cm	MDC-ORT-08636	40	NS-ORT-08636	40

*Note: The drape sizes are for information purposes. It can be produced in any desired sizes and fabric types.*

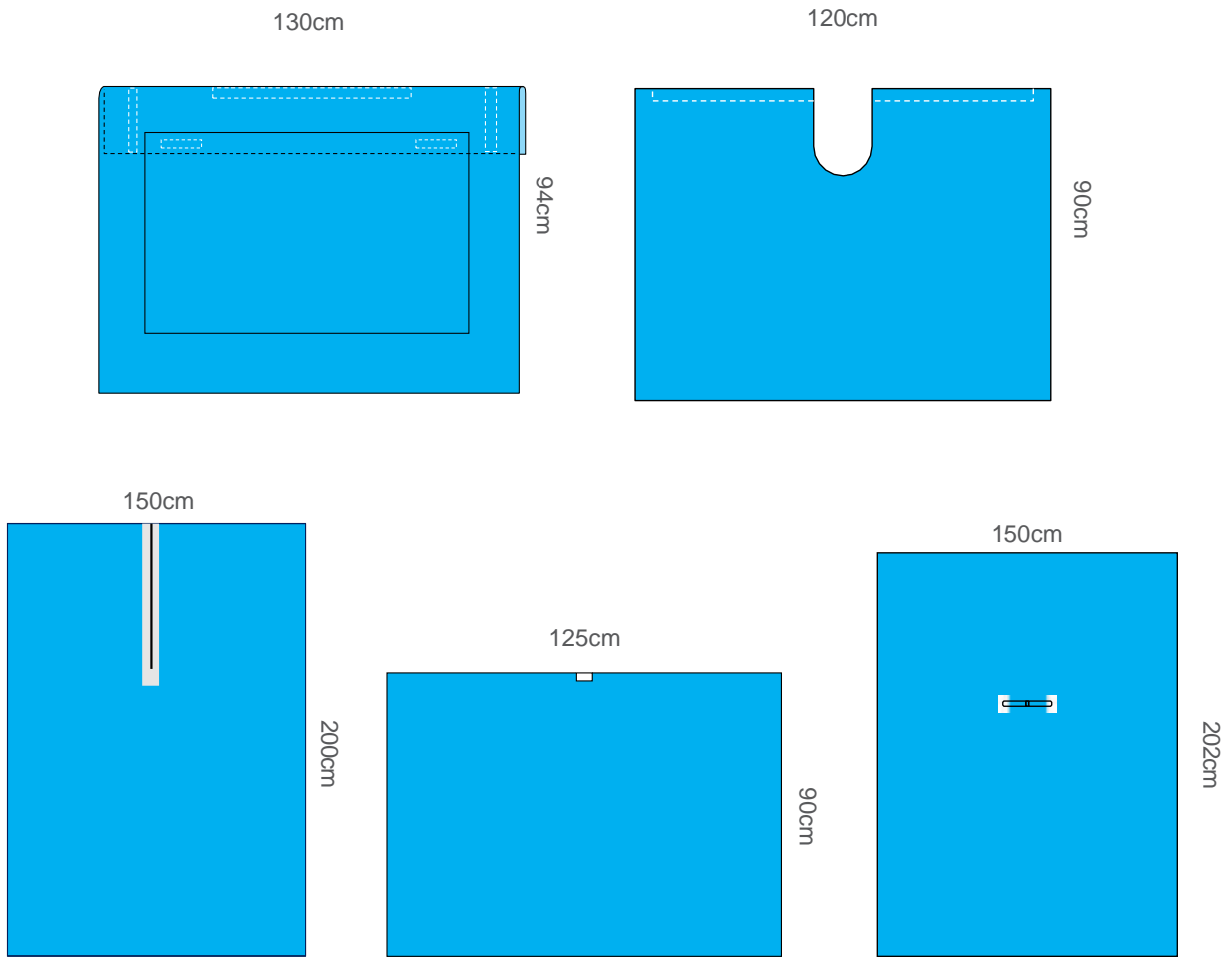

Sizes	Sterile	Units per Package	Non-Sterile	Units per Package
94 X 130 cm	MDC-ORT-08637	40	NS-ORT-08637	40
90 X 120 cm	MDC-ORT-08638	40	NS-ORT-08638	40
150 X 200 cm	MDC-ORT-08639	40	NS-ORT-08639	40
90 X 125 cm	MDC-ORT-08640	40	NS-ORT-08640	40
150 X 202 cm	MDC-ORT-08641	40	NS-ORT-08641	40

*Note: The drape sizes are for information purposes. It can be produced in any desired sizes and fabric types.*

Rhinoplasty Drape

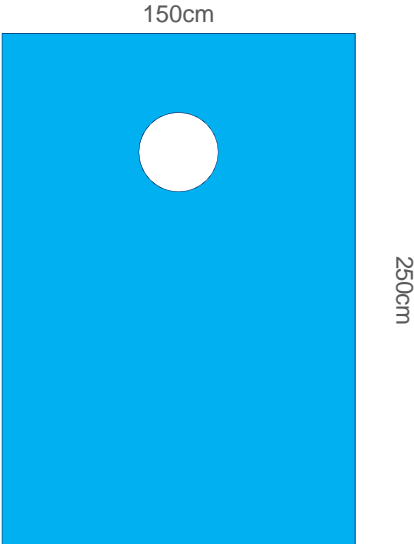

Sizes	Sterile	Units per Package	Non-Sterile	Units per Package
150 X 250 cm	MDC-ORT-08642	40	NS-ORT-08642	40

*Note: The drape sizes are for information purposes. It can be produced in any desired sizes and fabric types.*

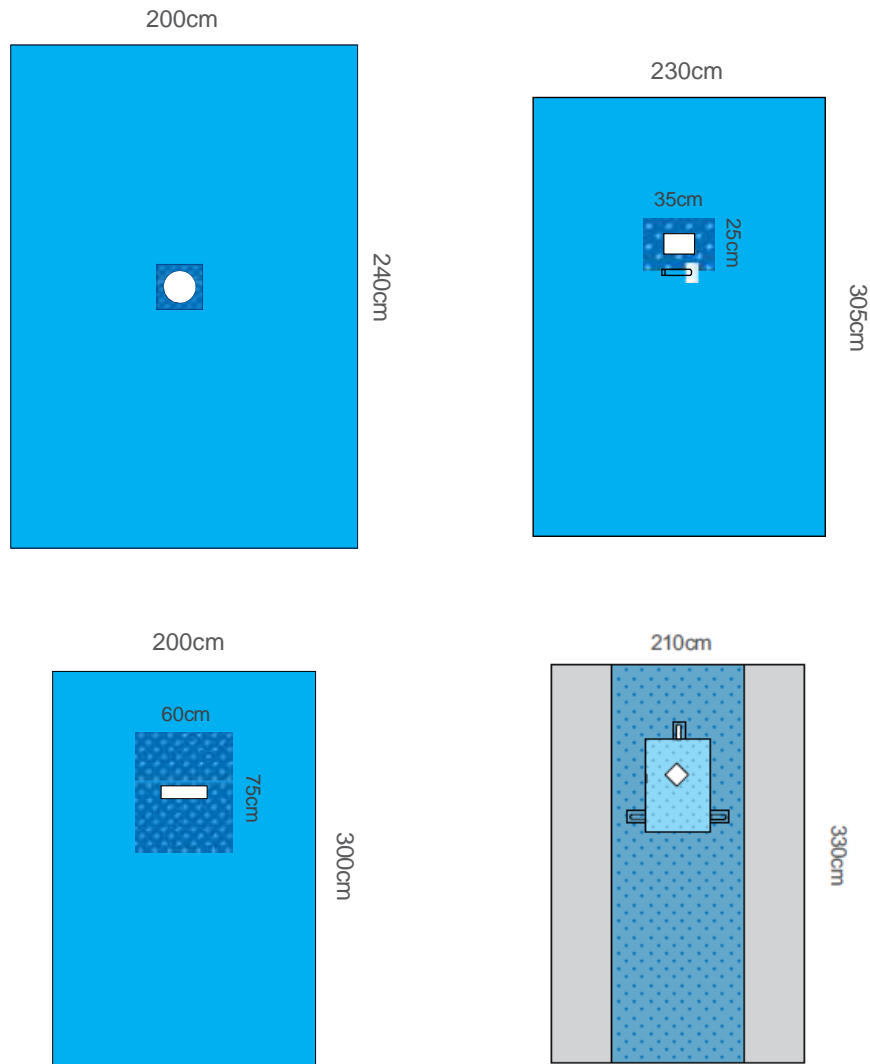

Sizes	Sterile	Units per Package	Non-Sterile	Units per Package
200 X 240 cm	MDC-ORT-08643	40	NS-ORT-08643	40
230 X 305 cm	MDC-ORT-08644	40	NS-ORT-08644	40
200 X 300 cm	MDC-ORT-08645	40	NS-ORT-08645	40
210 X 330 cm	MDC-ORT-08646	40	NS-ORT-08646	40

*Note: The drape sizes are for information purposes. It can be produced in any desired sizes and fabric types.*

## Dental Drape

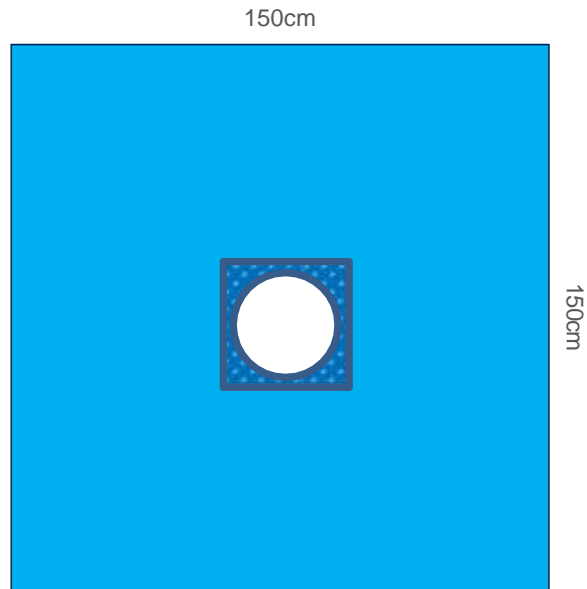

Sizes	Sterile	Units per Package	Non-Sterile	Units per Package
150 X 150 cm	MDC-ORT-08647	40	NS-ORT-08647	40

*Note: The drape sizes are for information purposes. It can be produced in any desired sizes and fabric types.*



## General Surgery Drape Sets



## General Surgery Drape Set

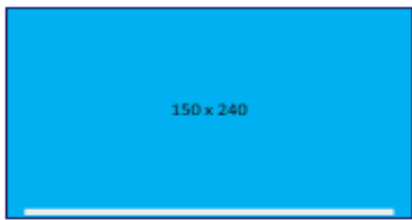

ANESTHESIA DRAPE



SIDE TAPED DRAPE

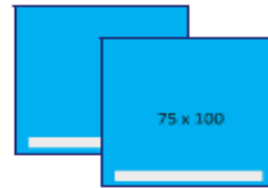

SIDE TAPED DRAPE



DRAPE FOR MAYO STAND

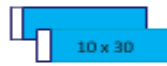

OPTAPE

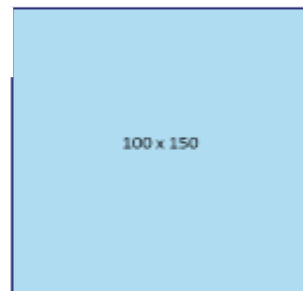

TOOLS TABLE DRAPE



STANDARD SURGICAL GOWN

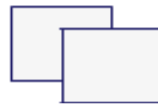

TOWEL

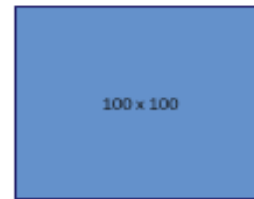

PACK

REF. MDC-ORTS-0205

General surgery

	Sizes	Pieces
ANESTHESIA DRAPE	150 x240	1
SIDE TAPED DRAPE	150 x180	1
SIDE TAPED DRAPE	75 x 100	2
TOOLS TABLE DRAPE	100 x150	1
DRAPE FOR MAYO STAND	80 x 150	1
OPTAPE	10 x 30	2
STANDARD SURGICAL GOWN	L	2
TOWEL	40 x 40	2
PACK	100 x 100	1

Note: The set contents are for information purposes. The optional production can be done.

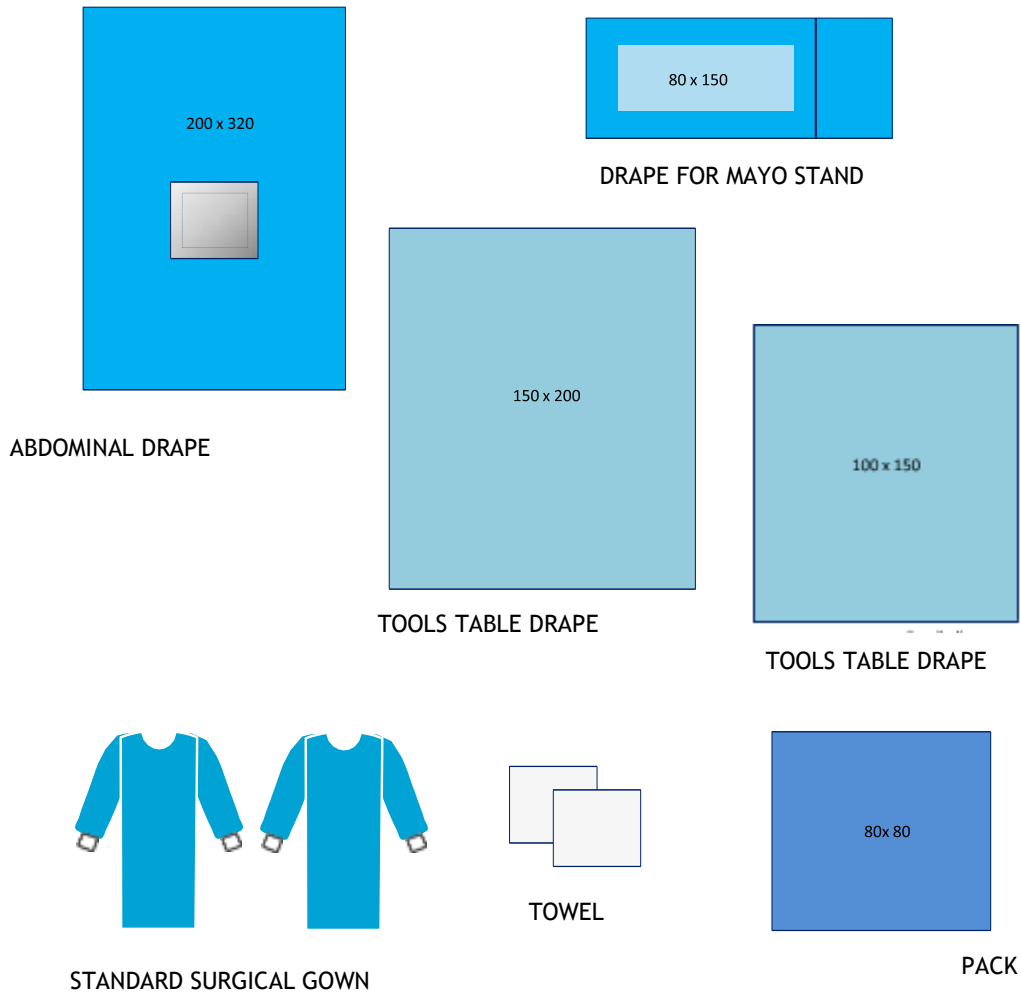

**REF. MDC-ORTS-0345**

Abdominal Drape Set		Sizes	Pieces
	ABDOMINAL DRAPE	200 X 320	1
	TOOLS TABLE DRAPE	100 X 150	1
	TOOLS TABLE DRAPE	150 X 200	1
	DRAPE FOR MAYO STAND	80 X 150	1
	STANDARD SURGICAL GOWN	L	2
	TOWEL	40 X 40	2
	PACK	80 X 80	1

*Note: The set contents are for information purposes. The optional production can be done.*



## Laparotomy Drape Set

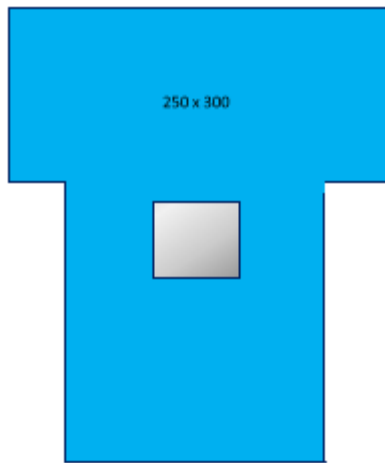

LAPAROTOMY DRAPE

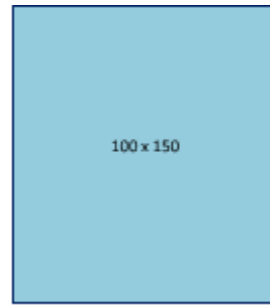

TOOLS TABLE DRAPE

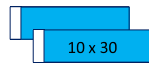

OPTAPE

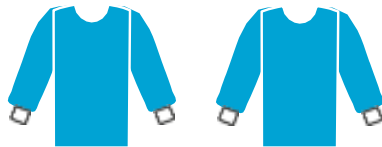

STANDARD SURGICAL GOWN

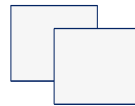

TOWEL

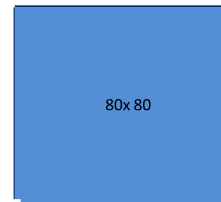

PACK

**REF. MDC-ORTS-0881**

Laparotomy Drape Set

	Sizes	Pieces
LAPAROTOMY DRAPE	250 X 300	1
TOOLS TABLE DRAPE	100 X 150	1
OPTAPE	10 X 30	1
STANDARD SURGICAL GOWN	L	2
TOWEL	40 X 40	2
PACK	80 X 80	1

*Note: The set contents are for information purposes. The optional production can be done.*

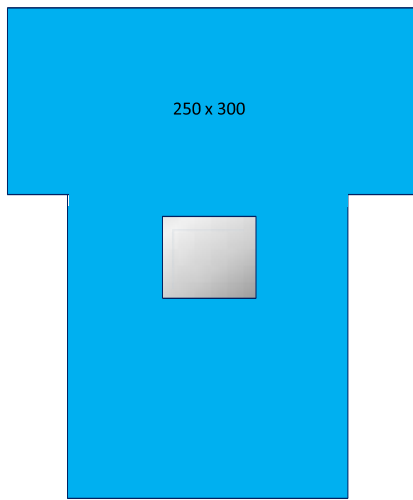

LAPAROSCOPY DRAPE

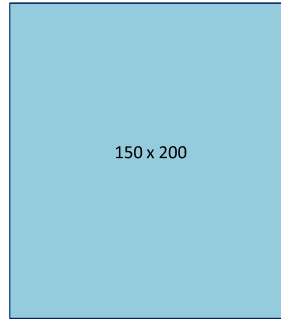

TOOLS TABLE DRAPE

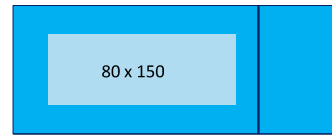

DRAPE FOR MAYO STAND

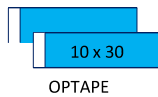

OPTAPE



STANDARD SURGICAL GOWN

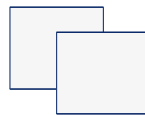

TOWEL

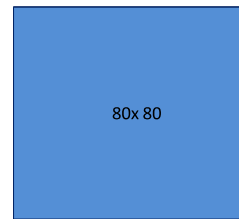

PACK

**REF. MDC-ORTS-0001**

Laparoscopy Drape Set

	Sizes	Pieces
LAPAROSCOPY DRAPE	250 X 300	1
TOOLS TABLE DRAPE	100 X 150	1
DRAPE FOR MAYO STAND	80 X 150	1
OPTAPE	10 X 30	2
STANDARD SURGICAL GOWN	L	2
TOWEL	40 X 40	2
PACK	80 X 80	1

*Note: The set contents are for information purposes. The optional production can be done.*

## Minor Surgery Drape Set

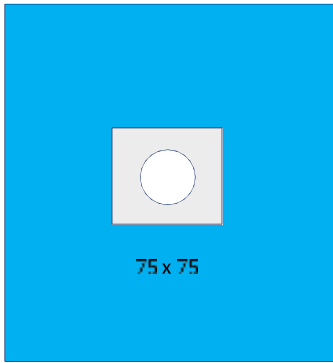

FENESTRATED MINOR DRAPE

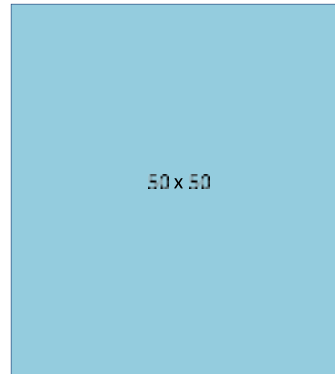

TOOLS TABLE DRAPE



STANDARD SURGICAL GOWN

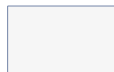

TOWEL

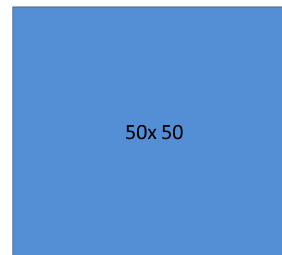

PACK

**REF. MDC-ORTS-0193**

Minor Surgery  
Drape Set

	Sizes	Pieces
FENESTRATED MINOR DRAPE	75 X 75	1
TOOLS TABLE DRAPE	50 X 50	1
STANDARD SURGICAL GOWN	L	1
TOWEL	20 X 40	1
PACK	50 X 50	1

*Note: The set contents are for information purposes. The optional production can be done.*



Surgical Drape Sets for Orthopedics



## Arthroscopy Drape Set

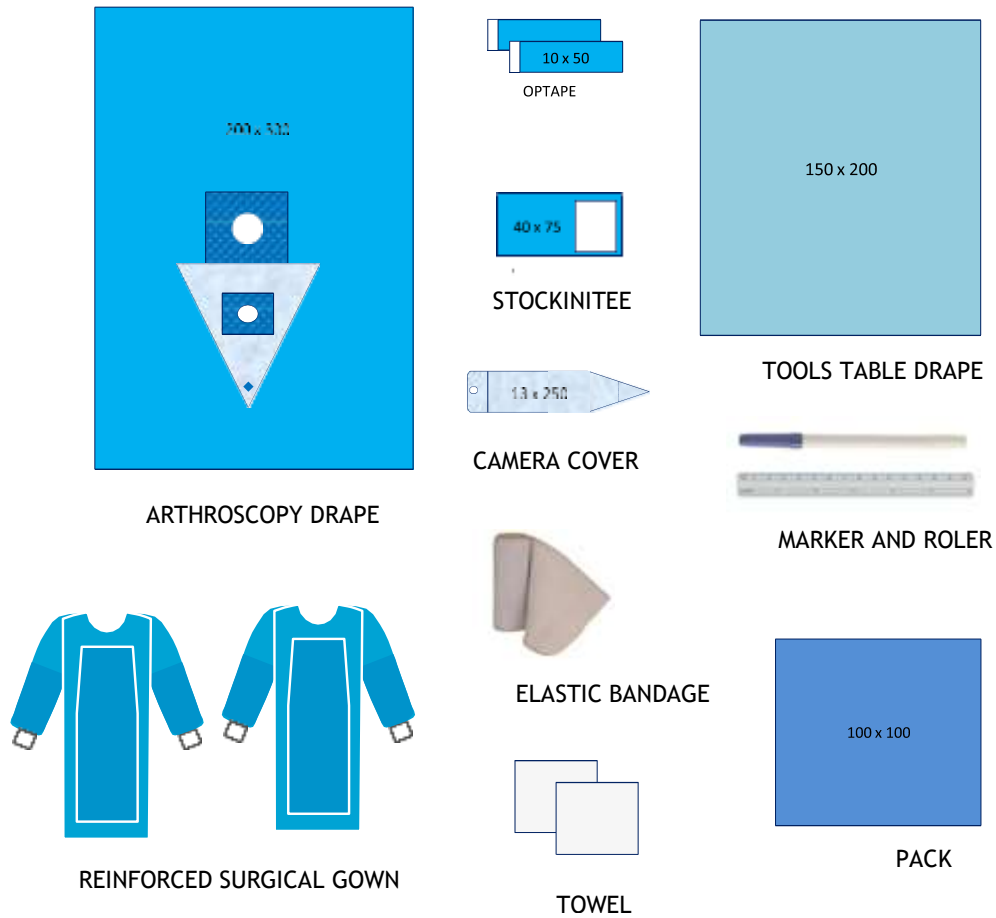

REF. MDC-ORTS-0133

### ARTHROSCOPY DRAPE SET

	Sizes	Pieces
ARTHROSCOPY DRAPE	200 X 300	1
TOOLS TABLE DRAPE	150 X 200	1
STOCKINITTE	40 X 75	1
CAMERA COVER	13 X 250	1
MARKER AND ROLER		1
ELASTIC BANDAGE	10 x 200	1
OPTAPE	10 X 50	2
REINFORCED SURGICAL GOWN	L	2
TOWEL	40 x 40	2
PACK	100 x 100	1

Note: The set contents are for information purposes. The optional production can be done.

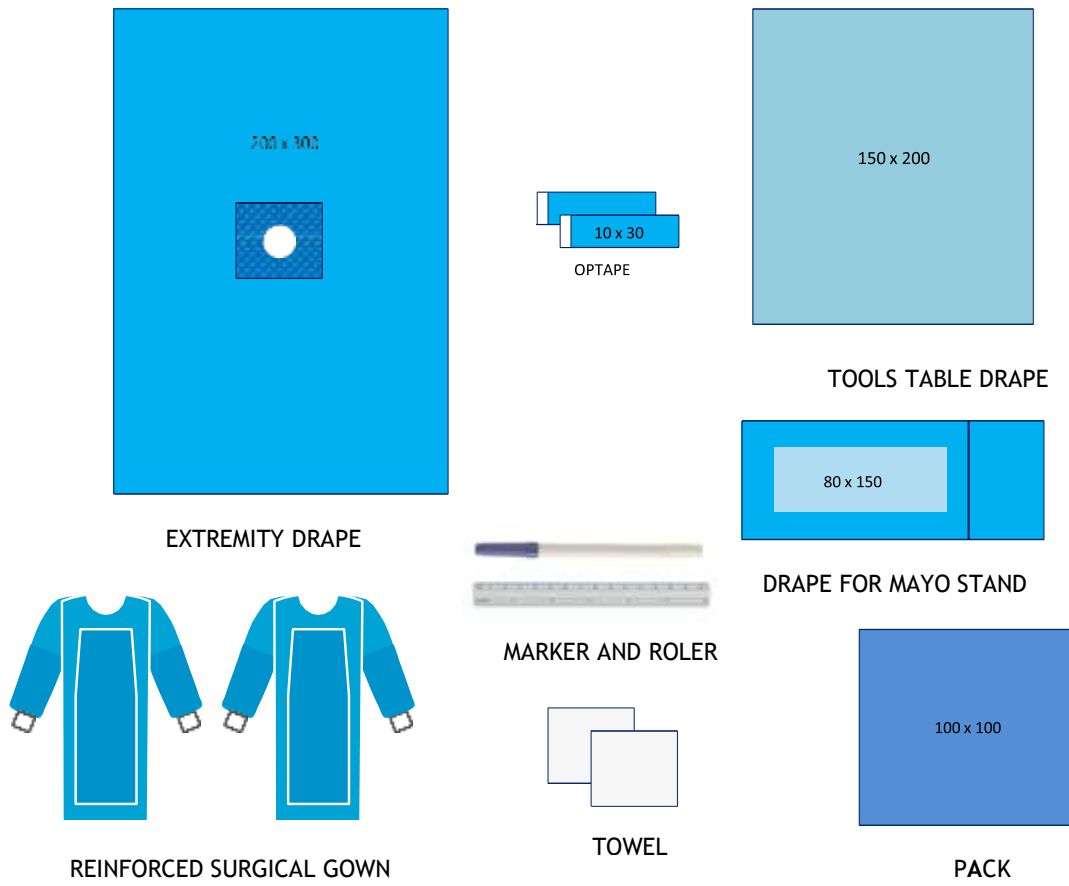

REF. MDC-ORTS-0097

EXTREMITY DRAPE SET

	Sizes	Pieces
EXTREMITY DRAPE	200 X 300	1
TOOLS TABLE DRAPE	150 X 200	1
DRAPE FOR MAYO STAND	80 X 150	1
OPTAPE	10 X 30	1
MARKER AND ROLER		1
REINFORCED SURGICAL GOWN	L	2
TOWEL	40 x 40	2
PACK	100 x 100	1

Note: The set contents are for information purposes. The optional production can be done.

## Hand Surgery Drape Set

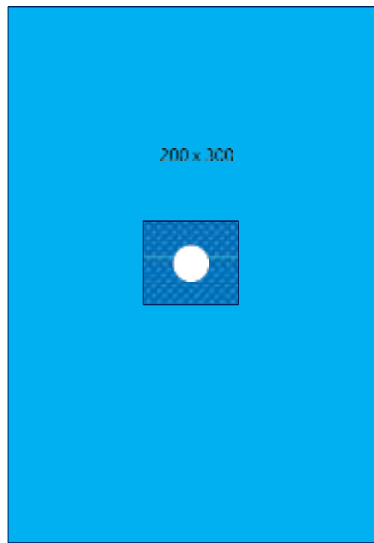

EXTREMITY DRAPE

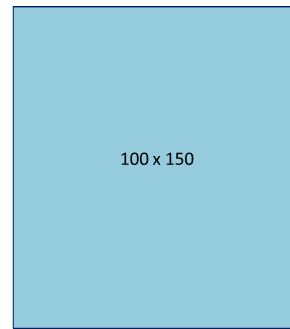

TOOLS TABLE DRAPE

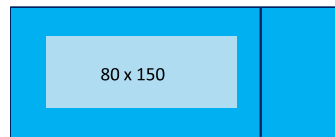

DRAPE FOR MAYO STAND

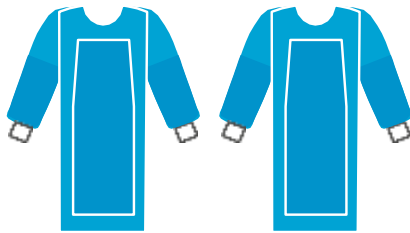

REINFORCED SURGICAL GOWN

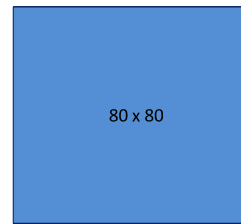

PACK

**REF. MDC-ORTS-0177**

HAND SURGERY DRAPE SET		Sizes	Pieces
	EXTREMITY DRAPE	200 X 300	1
	TOOLS TABLE DRAPE	150 X 200	1
	DRAPE FOR MAYO STAND	80 X 150	1
	REINFORCED SURGICAL GOWN	L	2
	PACK	80 x 80	1

*Note: The set contents are for information purposes. The optional production can be done.*

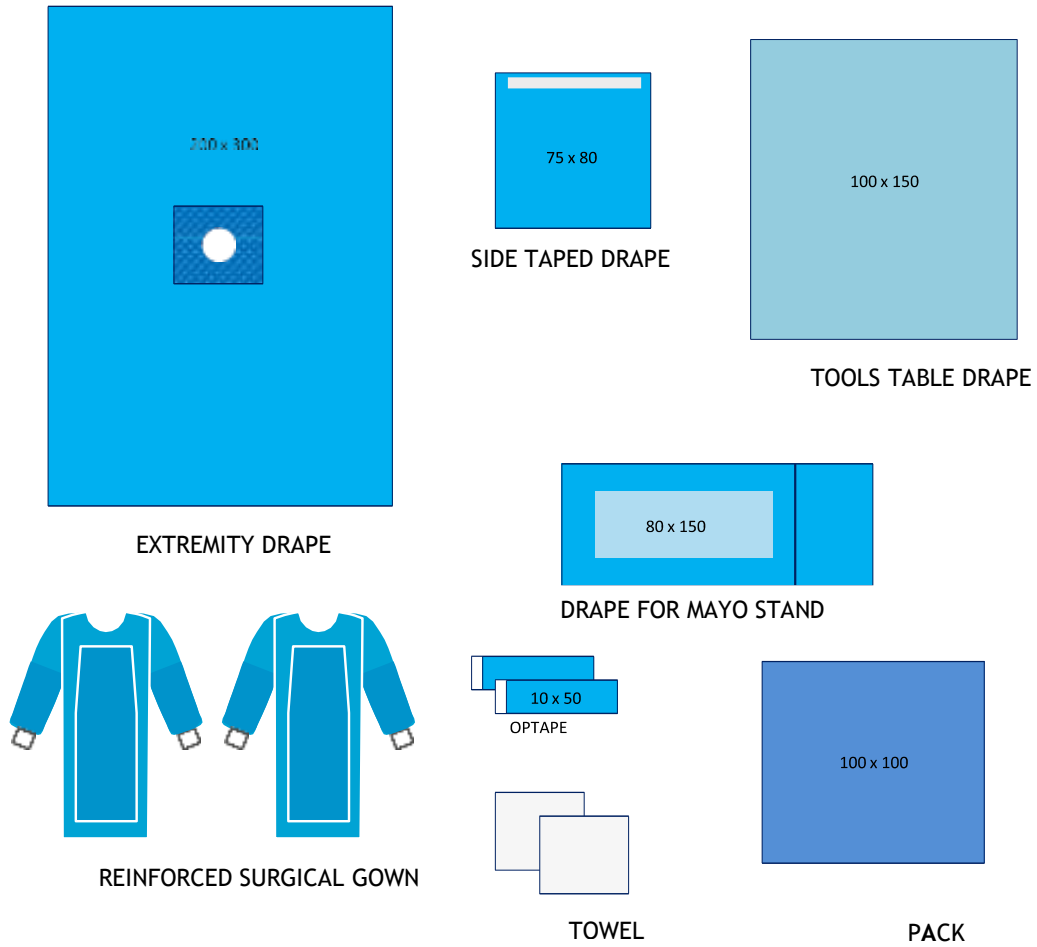

**REF. MDC-ORTS-0105**

KNEE DRAPE SET		Sizes	Pieces
	EXTREMITY DRAPE	200 X 300	1
	SIDE TAPED DRAPE	75 X 80	1
	TOOLS TABLE DRAPE	100 X 150	1
	DRAPE FOR MAYO STAND	80 X 150	1
	OPTAPE	10 X 50	2
	REINFORCED SURGICAL GOWN	L	2
	TOWEL	40 X 40	2
PACK	100 x 100	1	

*Note: The set contents are for information purposes. The optional production can be done.*



## Shoulder Drape Set

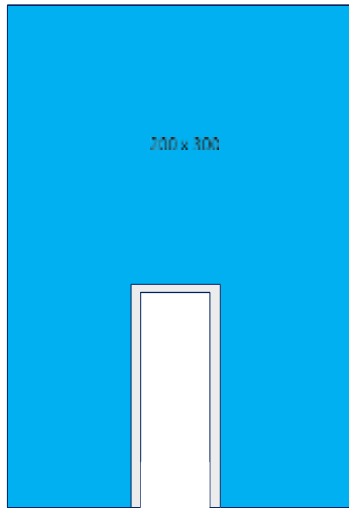

SHOULDER DRAPE

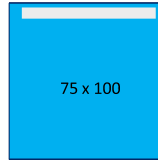

SIDE TAPED DRAPE

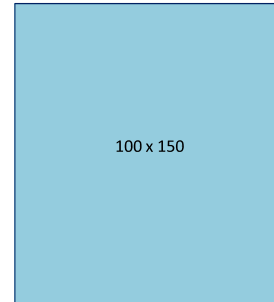

TOOLS TABLE DRAPE

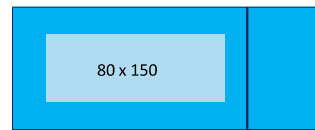

DRAPE FOR MAYO STAND

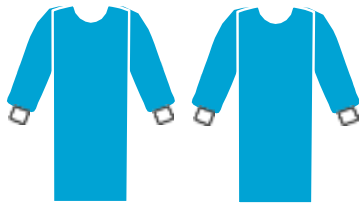

REINFORCED SURGICAL GOWN

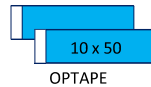

OPTAPE

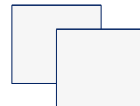

TOWEL

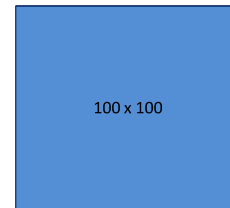

PACK

**REF. MDC-ORTS-0882**

SHOULDER DRAPE SET

	Sizes	Pieces
SHOULDER DRAPE	200 X 300	1
SIDE TAPED DRAPE	75 X 100	1
TOOLS TABLE DRAPE	100 X 150	1
DRAPE FOR MAYO STAND	80 X 150	1
OPTAPE	10 X 50	2
REINFORCED SURGICAL GOWN	L	2
TOWEL	40 X 40	2
PACK	100 x 100	1

*Note: The set contents are for information purposes. The optional production can be done.*

## Hip Drape Set

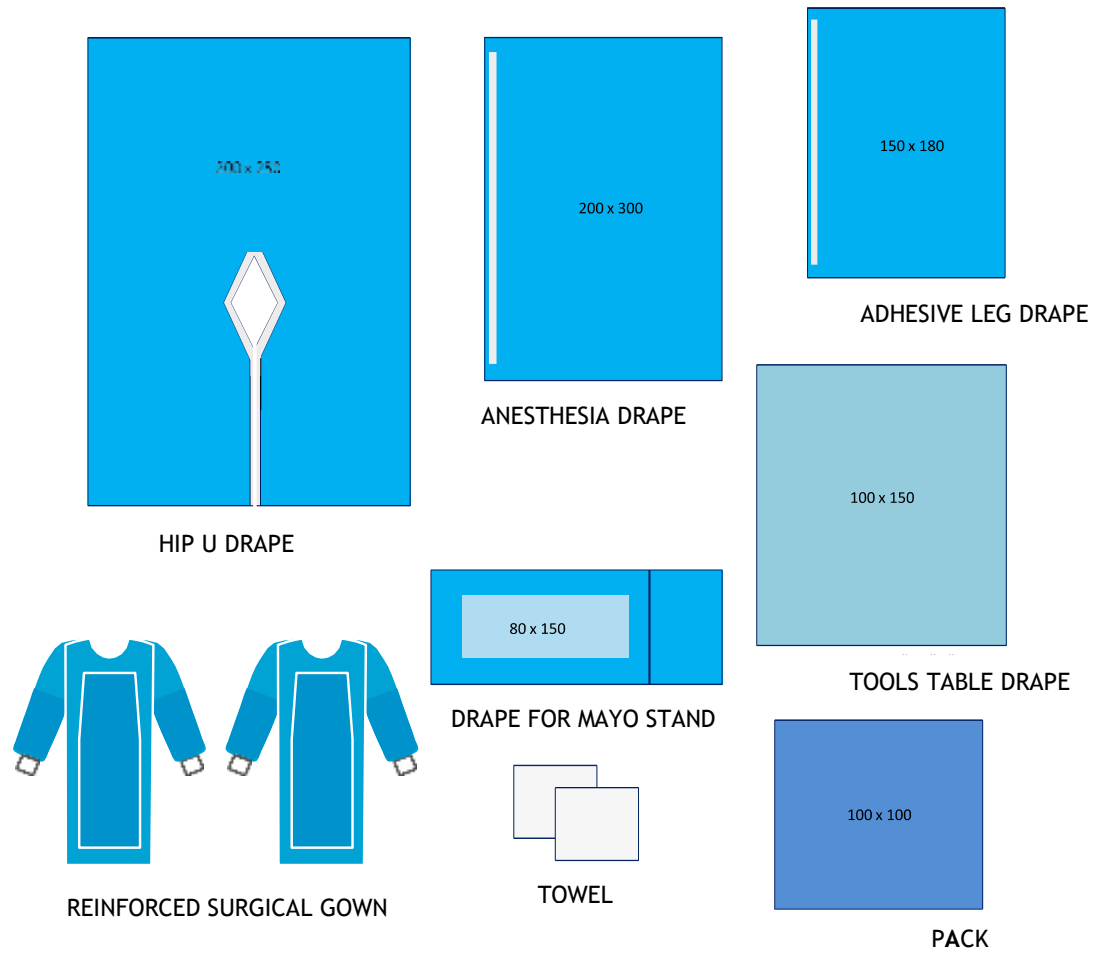

**REF. MDC-ORTS-0121**

HIP DRAPE SET		Sizes	Pieces
	HIP U DRAPE	200 X 250	1
	ADHESIVE ANESTHESIA DRAPE	200 X 300	1
	ADHESIVE LEG DRAPE	150 X 180	1
	TOOLS TABLE DRAPE	100 X 150	1
	DRAPE FOR MAYO STAND	80 X 150	2
	REINFORCED SURGICAL GOWN	L	2
	TOWEL	40 X 40	2
	PACK	100 x 100	1

*Note: The set contents are for information purposes. The optional production can be done.*

## Vertebra Drape Set

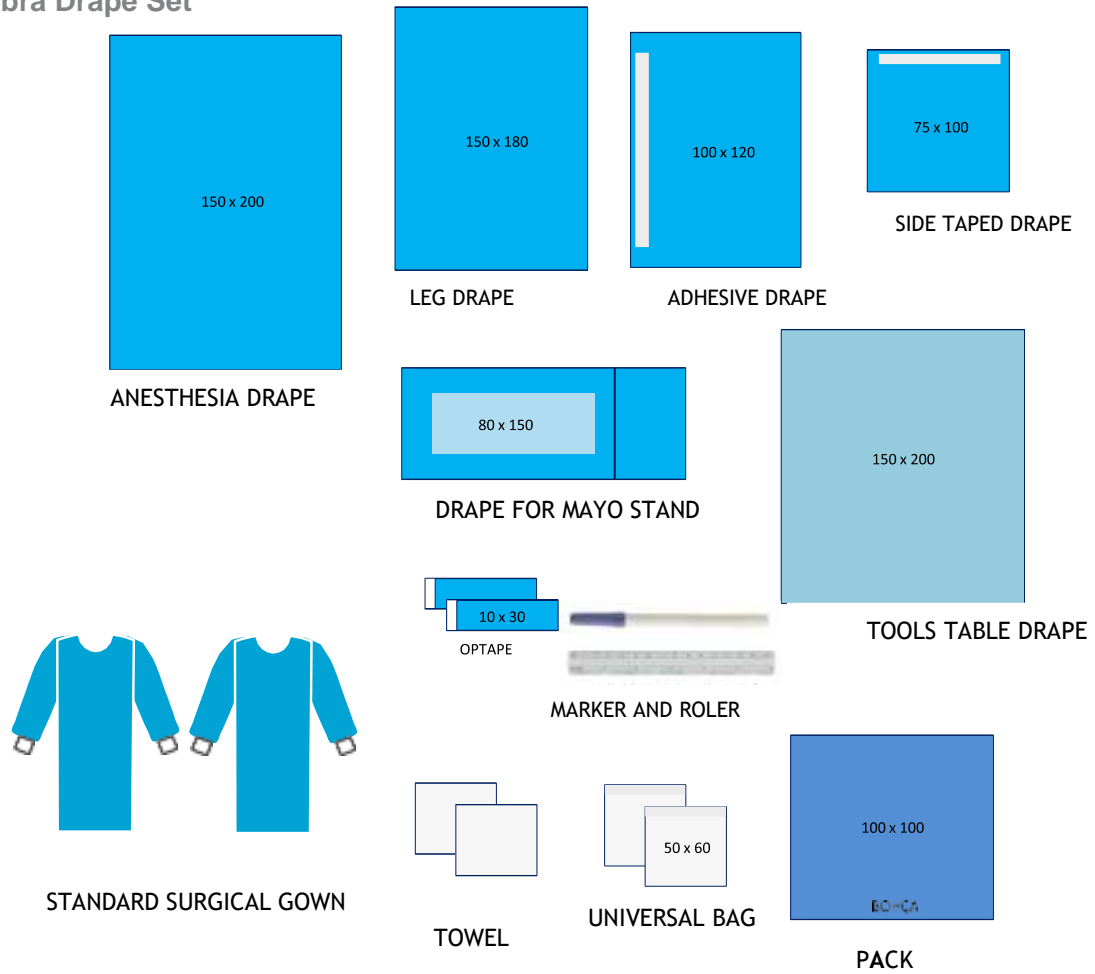

REF. MDC-ORTS-0137

	Sizes	Pieces
ANESTHESIA DRAPE	150 X 200	1
LEG DRAPE	150 X 180	1
TOOLS TABLE DRAPE	150 X 200	1
MAYO LEG DRAPE	80 X 150	1
ADHESIVE DRAPE	100 X 120	2
ADHESIVE DRAPE	75 X 100	2
OP-TAPE	10 X 30	2
MARKER AND ROLER		1
UNIVERSAL BAG	50 X 60	2
STANDARD SURGICAL GOWN	L	2
TOWEL	40 X 40	2
PACK	100 x 100	1

VERTEBRA DRAPE SET

Note: The set contents are for information purposes. The optional production can be done.



Surgical Drape Sets for Cardiology



## Angiography Drape Set

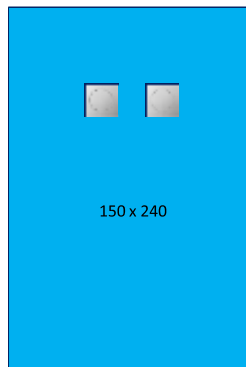

ANGIOGRAPHY DRAPE

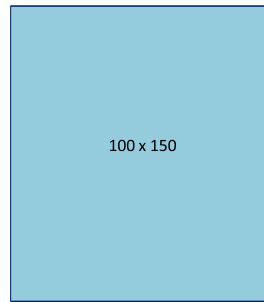

TOOLS TABLE DRAPE



SPONGE



FLUOROSCOPY CONTAINER



SOLUTION CONTAINER



STANDARD SURGICAL GOWN

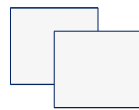

TOWEL

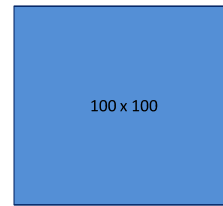

PACK

**REF. MDC-ORTS-0053**

ANGIOGRAPHY DRAPE SET

	Sizes	Pieces
ANGIOGRAPHY DRAPE	150 X 240	1
TOOLS TABLE DRAPE	100 X 150	1
SPONGE	7,5 X 7,5	10
SOLUTION CONTAINER	250 CC	1
FLUOROSCOPY CONTAINER	85 X 85	1
STANDARD SURGICAL GOWN	L	2
TOWEL	40 X 40	2
PACK	100 x 100	1

*Note: The set contents are for information purposes. The optional production can be done.*

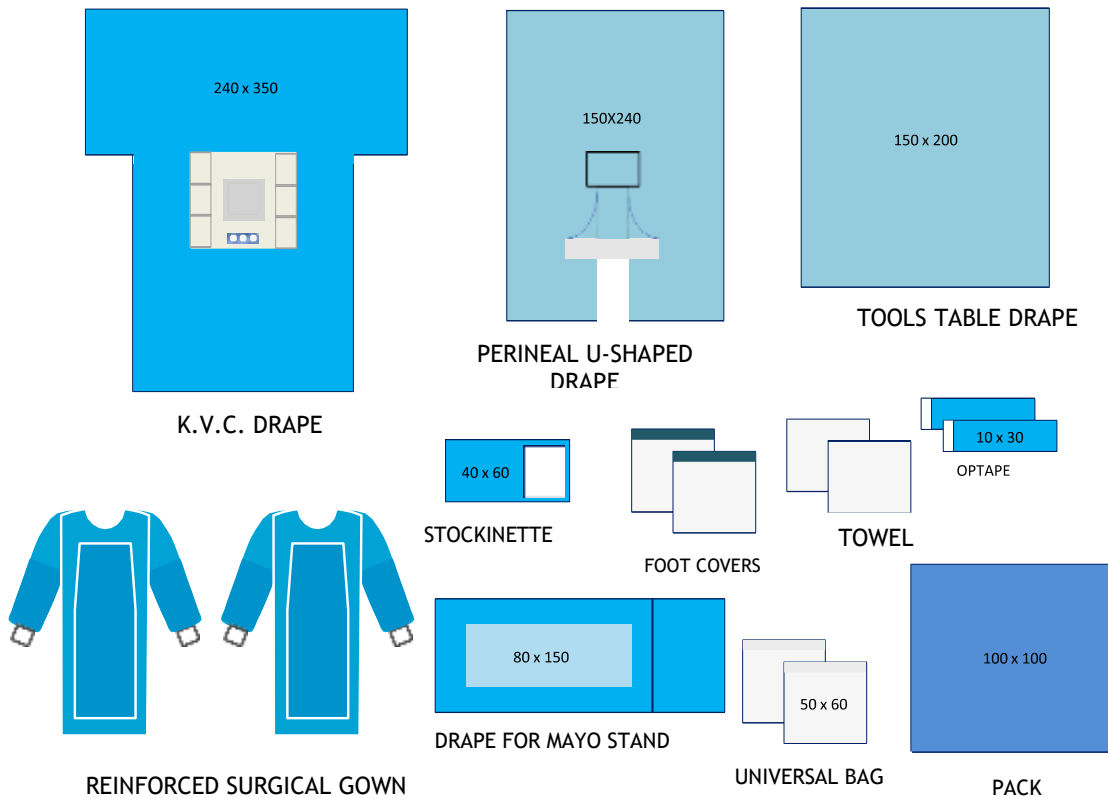

REF. MDC-ORTS-0085

ANJIOGRAPHY DRAPE SET		Sizes	Pieces
	K.V.C. DRAPE	240 X 350	1
	PERINEAL U-SHAPED DRAPE	150 X 240	1
	TOOLS TABLE DRAPE	150 X 200	1
	DRAPE FOR MAYO STAND	80 X 150	1
	STOCKINETTE	40 X 60	1
	FOOT COVERS	STANDARD	2
	OP-TAPE	10 X 30	2
	UNIVERSAL BAG	30 X 35	2
	REINFORCED SURGICAL GOWN	L	2
TOWEL	40 X 40	2	
PACK	100 x 100	1	

Note: The set contents are for information purposes. The optional production can be done.

## Cardiac Valve Replacement Drape Set

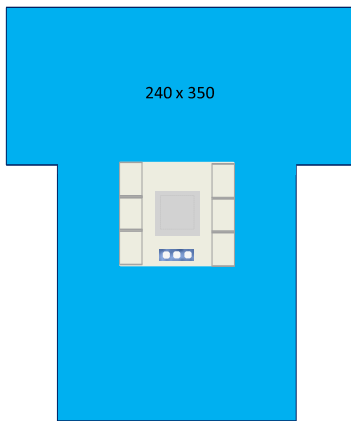

K.V.C. DRAPE

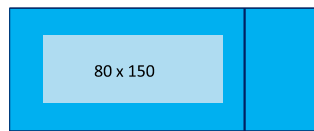

DRAPE FOR MAYO STAND

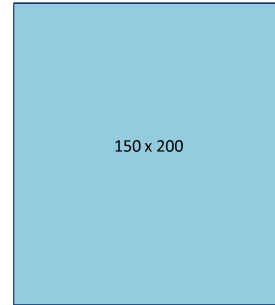

TOOLS TABLE DRAPE

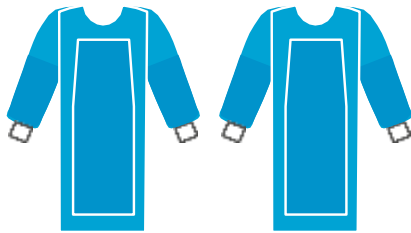

REINFORCED SURGICAL GOWN

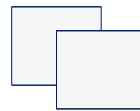

TOWEL

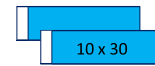

OPTAPE

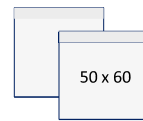

UNIVERSAL BAG

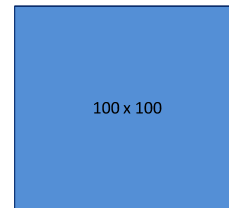

PACK

**REF. MDC-ORTS-0069**

CARDIAC VALVE REPLACEMENT DRAPE SET		Sizes	Pieces
	K.V.C. DRAPE	240 X 350	1
	TOOLS TABLE DRAPE	150 X 200	1
	DRAPE FOR MAYO STAND	80 X 150	1
	OP-TAPE	10 X 30	2
	UNIVERSAL BAG	30 X 35	2
	REINFORCED SURGERY GOWN	L	2
	TOWEL	40 X 40	2
	PACK	100 x 100	1

Note: The set contents are for information purposes. The optional production can be done.

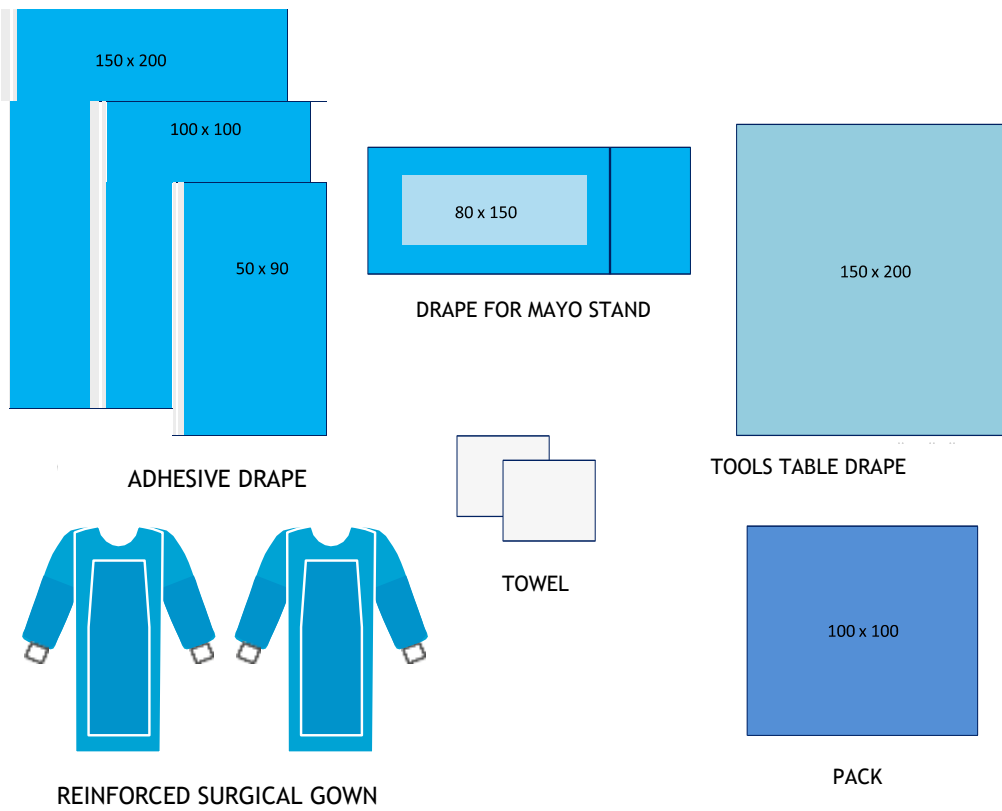

REF. MDC-ORTS-0041

CARDIOVASCULAR DRAPE SET		Sizes	Pieces
	ADHESIVE DRAPE	50 X 90	1
	ADHESIVE DRAPE	100 X 100	1
	ADHESIVE DRAPE	150 X 200	1
	TOOLS TABLE DRAPE	150 X 200	1
	DRAPE FOR MAYO STAND	80 X 150	1
	REINFORCED SURGERY GOWN	L	2
	TOWEL	40 X 40	2
PACK	100 x 100	1	

Note: The set contents are for information purposes. The optional production can be done.



The logo features a stylized, bold letter 'M' in a dark red color. The 'M' is composed of two main vertical strokes and a horizontal top bar, with a white negative space forming a central shape.

# Medicotex

Surgical Drape Sets for Gynecology



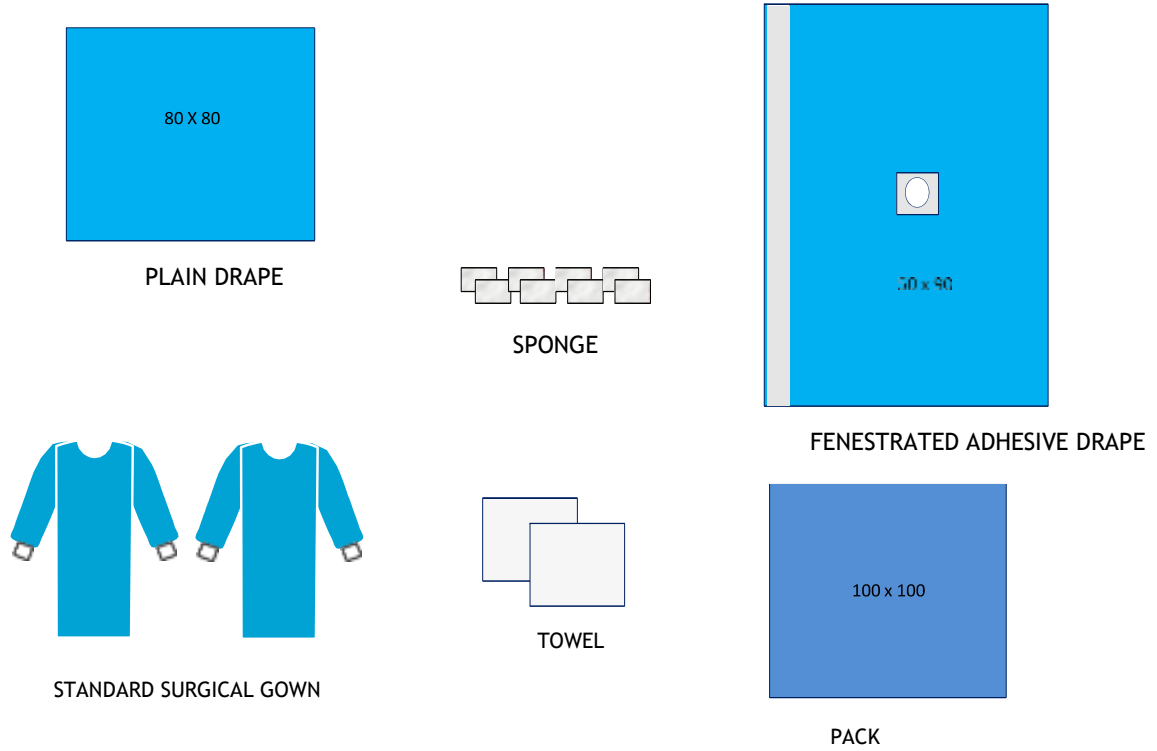

**REF. MDC-ORTS-0233**

E.T. DRAPE SET		Sizes	Pieces
	FENESTRATED ADHESIVE DRAPE	50 X 90	1
	PLAIN DRAPE	80 X 80	1
	SPONGE	7,5 X 7,5	10
	STANDARD SURGICAL GOWN	L	2
	TOWEL	40 X 40	2
	PACK	100 x 100	1

*Note: The set contents are for information purposes. The optional production can be done.*

## I. V. F. Drape Set

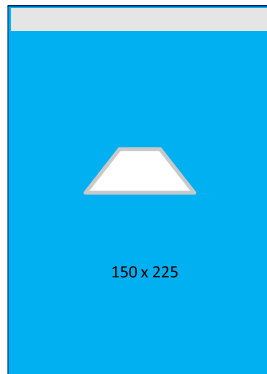

I.V.F. DRAPE



SPONGE

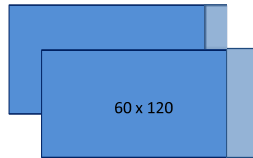

LEG COVER

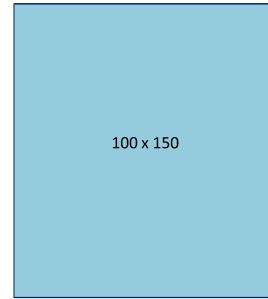

TOOLS TABLE DRAPE

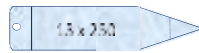

CAMERA COVER

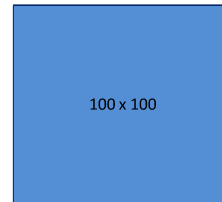

PACK



STANDARD SURGICAL GOWN

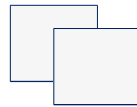

TOWEL

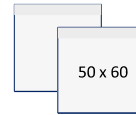

UNIVERSAL BAG

**REF. MDC-ORTS-0225**

I.V.F. DRAPE SET

	Sizes	Pieces
I.V.F. DRAPE	150 X 225	1
TOOLS TABLE DRAPE	100 X 150	1
LEG COVER	50 X 120	2
SPONGE	7,5 X 7,5	10
CAMERA COVER	13 X 250	1
UNIVERSAL BAG	50 X 60	1
STANDARD SURGICAL GOWN	L	2
TOWEL	40 X 40	2
PACK	100 x 100	1

*Note: The set contents are for information purposes. The optional production can be done.*

## Maternity Drape Set

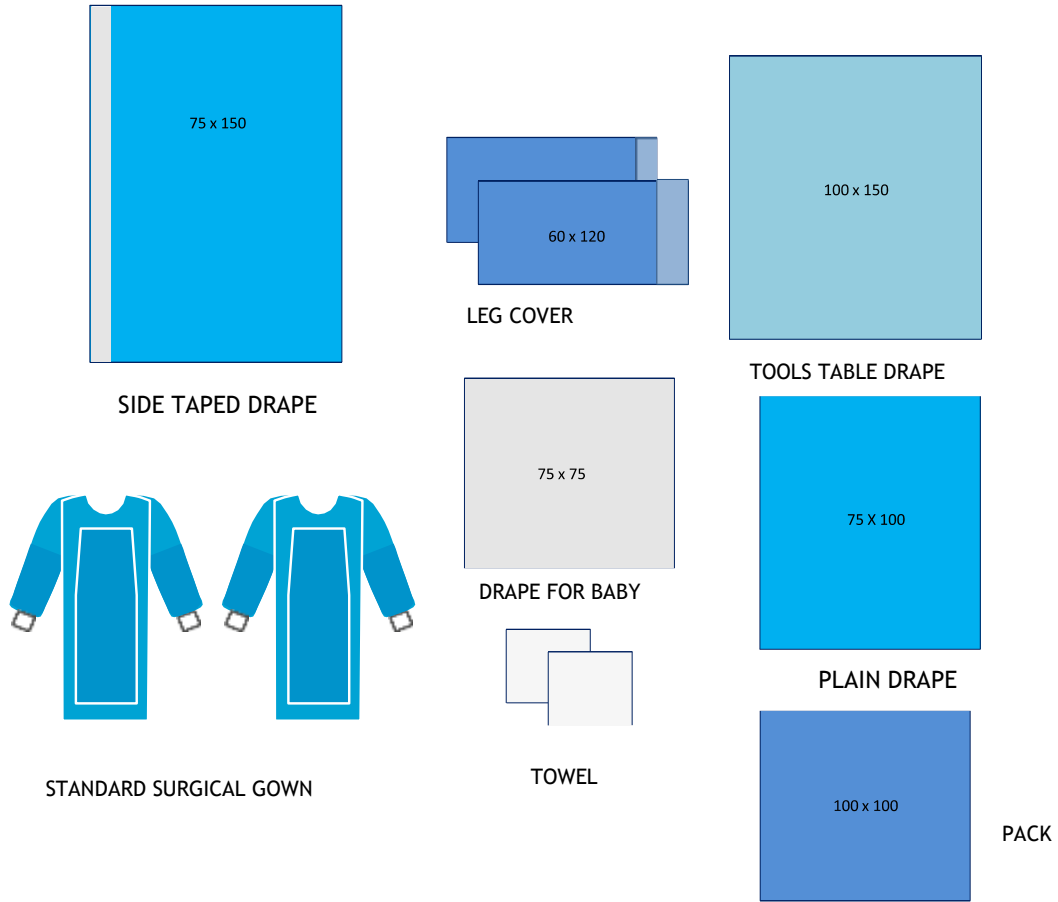

REF. MDC-ORTS-0245

MATERNITY DRAPE SET		Sizes	Pieces
	SIDE TAPED DRAPE	75 X 150	1
	DRAPE FOR BABY	75 X 75	1
	TOOLS TABLE DRAPE	100 X 150	1
	PLAIN DRAPE	75 X 100	10
	LEG COVER	60 X 120	1
	UNIVERSAL BAG	50 X 60	1
	REINFORCED SURGICAL GOWN	L	2
	TOWEL	40 X 40	2
	PACK	100 x 100	1

Note: The set contents are for information purposes. The optional production can be done.

## Cesarean Drape Set

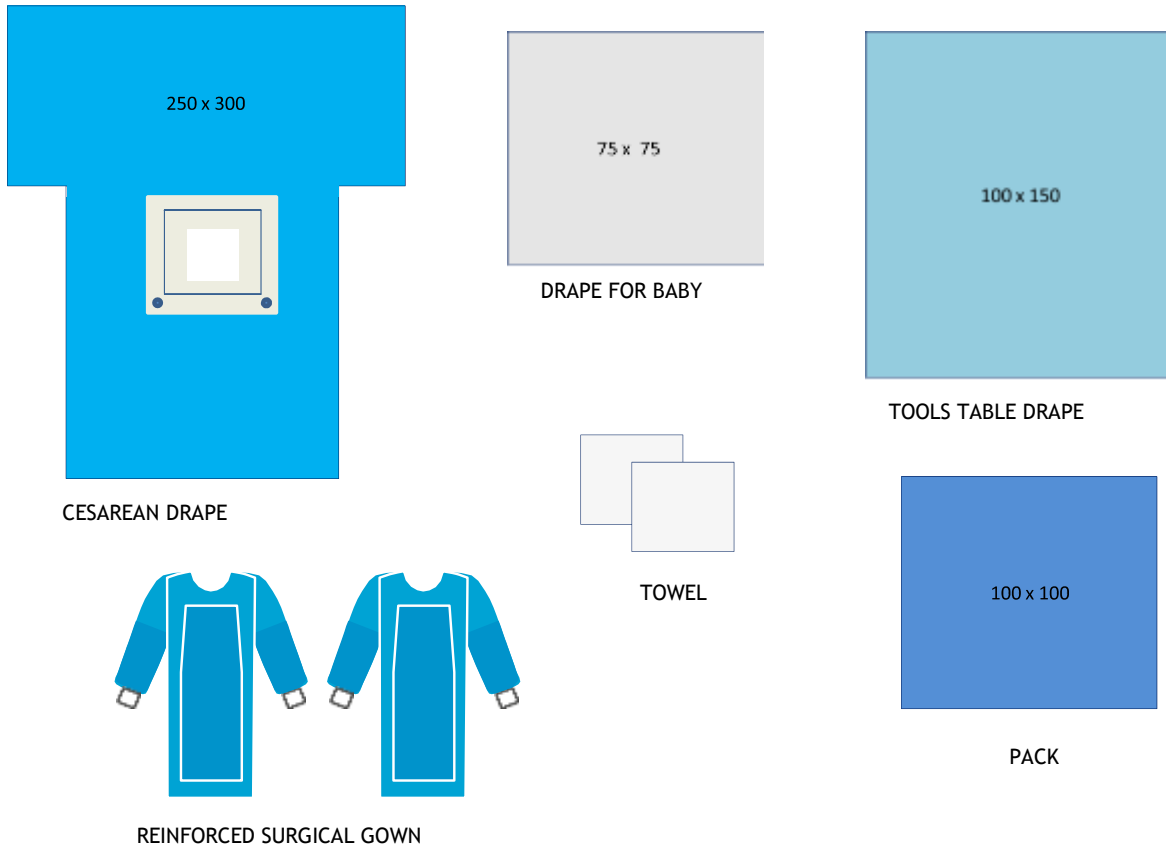

**REF. MDC-ORTS-0241**

CESAREAN DRAPE SET		Sizes	Pieces
	CESAREAN DRAPE	75 X 150	1
	TOOLS TABLE DRAPE	100 X 150	1
	DRAPE FOR BABY	75 X 75	1
	REINFORCED SURGICAL GOWN	L	2
	TOWEL	40 X 40	2
	PACK	100 x 100	1

*Note: The set contents are for information purposes. The optional production can be done.*

## O.P.U. Drape Set

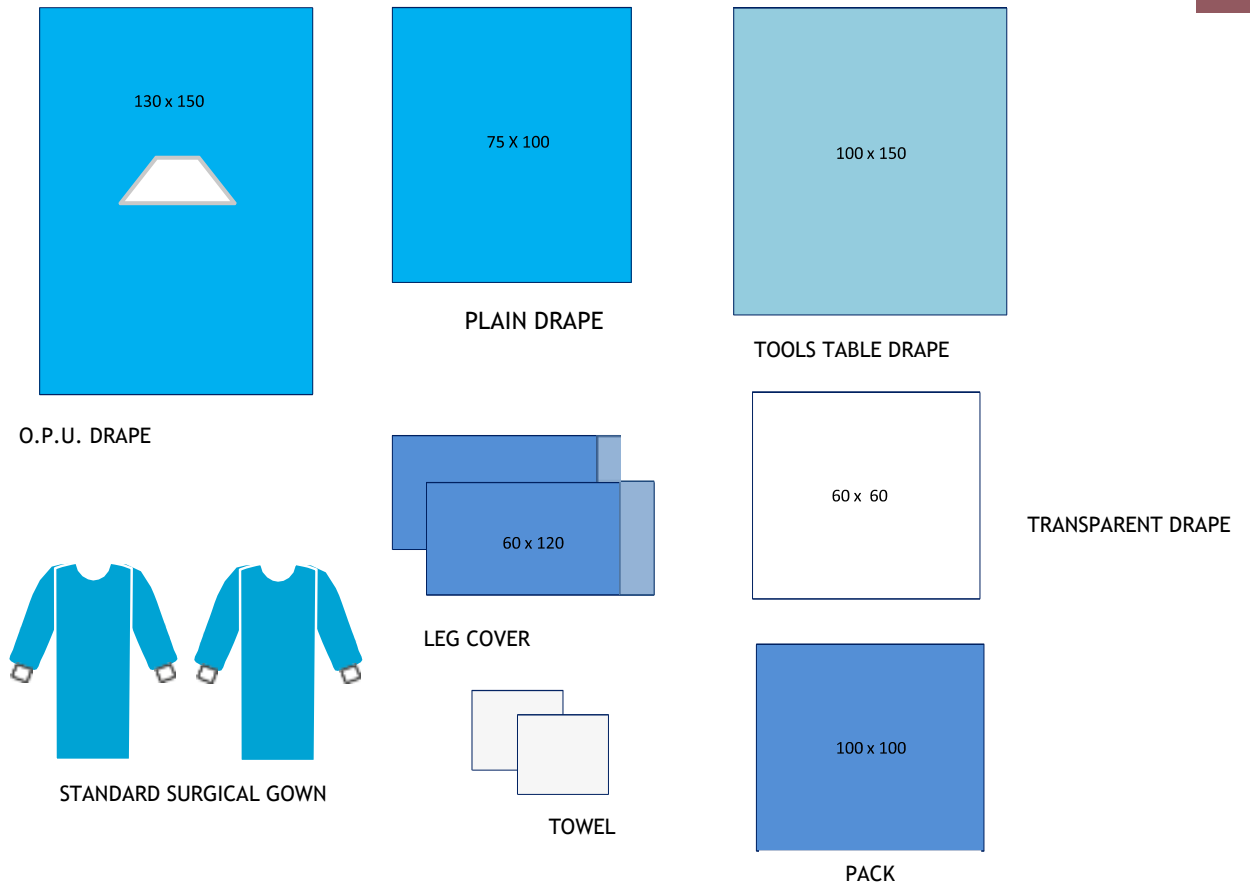

**REF. MDC-ORTS-0381**

O.P.U. DRAPE SET		Sizes	Pieces
	O.P.U. DRAPE	130 X 150	1
	PLAIN DRAPE	75 X 100	1
	TRANSPARENT DRAPE	60 X 60	1
	TOOLS TABLE DRAPE	100 X 150	1
	LEG COVER	60 X115	1
	STANDARD SURGICAL GOWN	L	2
	TOWEL	40 X 40	2
PACK	100 x 100	1	

*Note: The set contents are for information purposes. The optional production can be done.*



## Neurosurgical Drape Sets



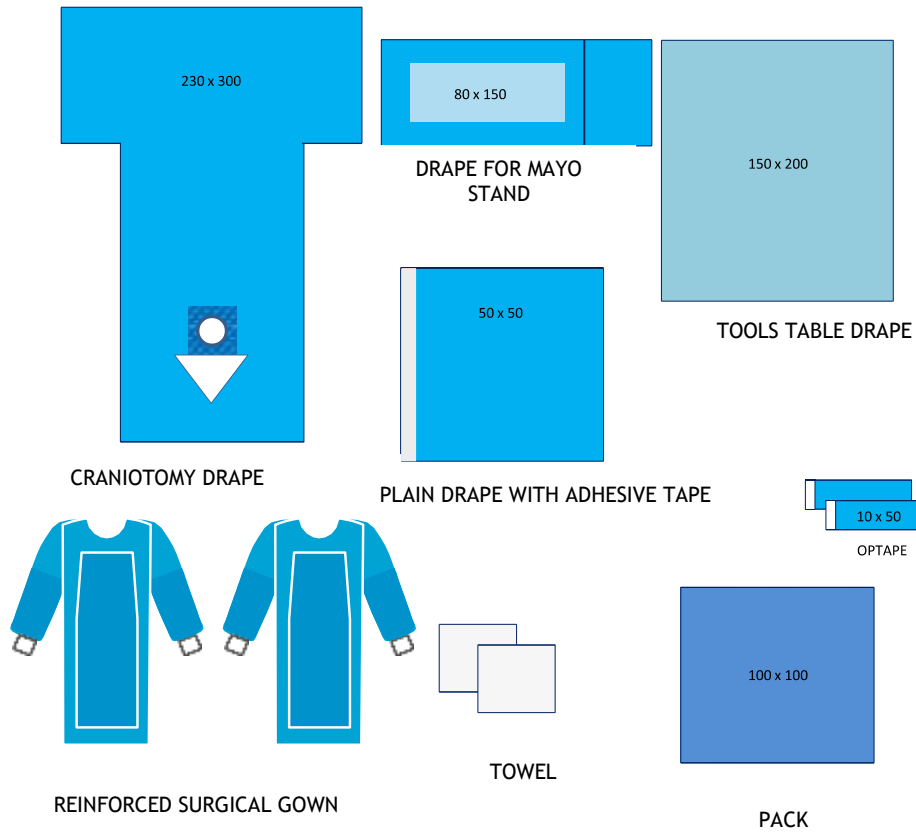

REF. MDC-ORTS-0401

CRANIOTOMY DRAPE SET		Sizes	Pieces
	CRANIOTOMY DRAPE	230 X 300	1
	DRAPE FOR MAYO STAND	80 X 150	1
	OP-TAPE	10 X 50	1
	PLAIN DRAPE WITH ADHESIVE TAPE	50 X 50	4
	TOOLS TABLE DRAPE	150 X 200	1
	REINFORCED SURGICAL GOWN	L	2
	TOWEL	40 X 40	2
	PACK	100 x 100	1

Note: The set contents are for information purposes. The optional production can be done.



## Shunt Drape Set

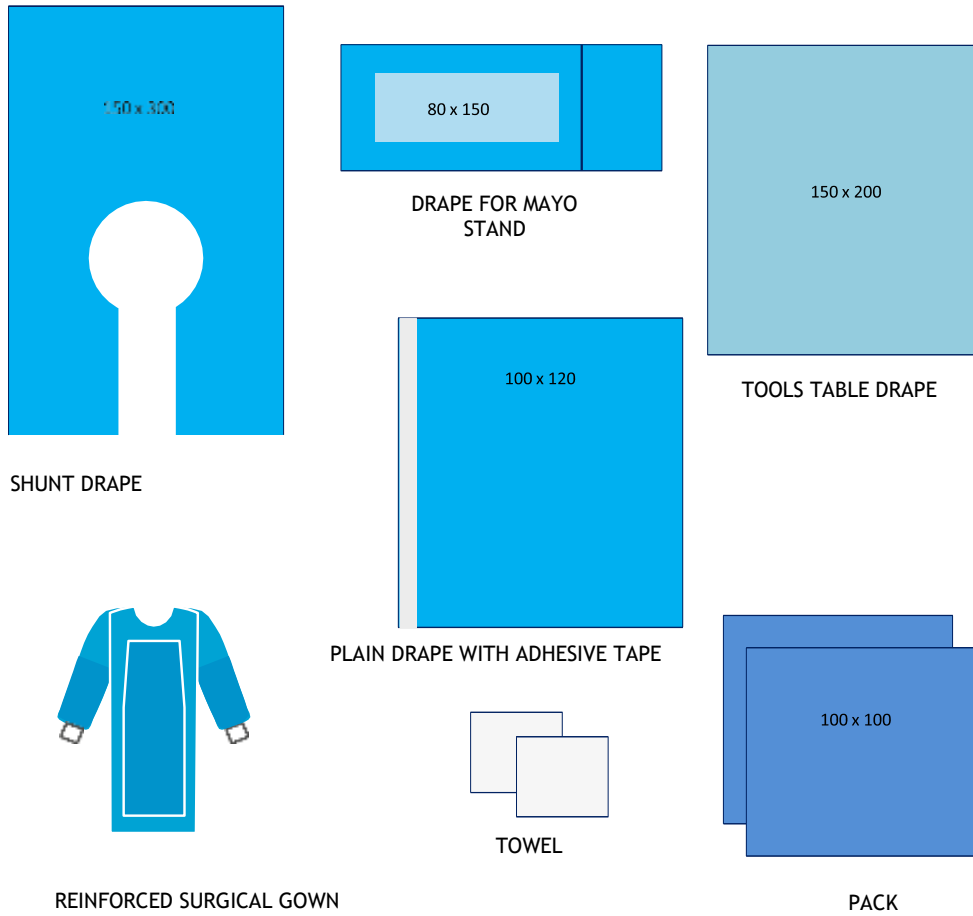

**REF. MDC-ORTS-0013**

SHUNT DRAPE SET		Sizes	Pieces
	SHUNT DRAPE	230 X 300	1
	TOOLS TABLE DRAPE	150 X 200	1
	DRAPE FOR MAYO STAND	80 X 160	1
	PLAIN DRAPE WITH ADHESIVE TAPE	100 X 120	2
	REINFORCED SURGICAL GOWN	L	1
	TOWEL	40 X 40	2
	PACK	100 x 100	2

*Note: The set contents are for information purposes. The optional production can be done.*

## Spinal Drape Set

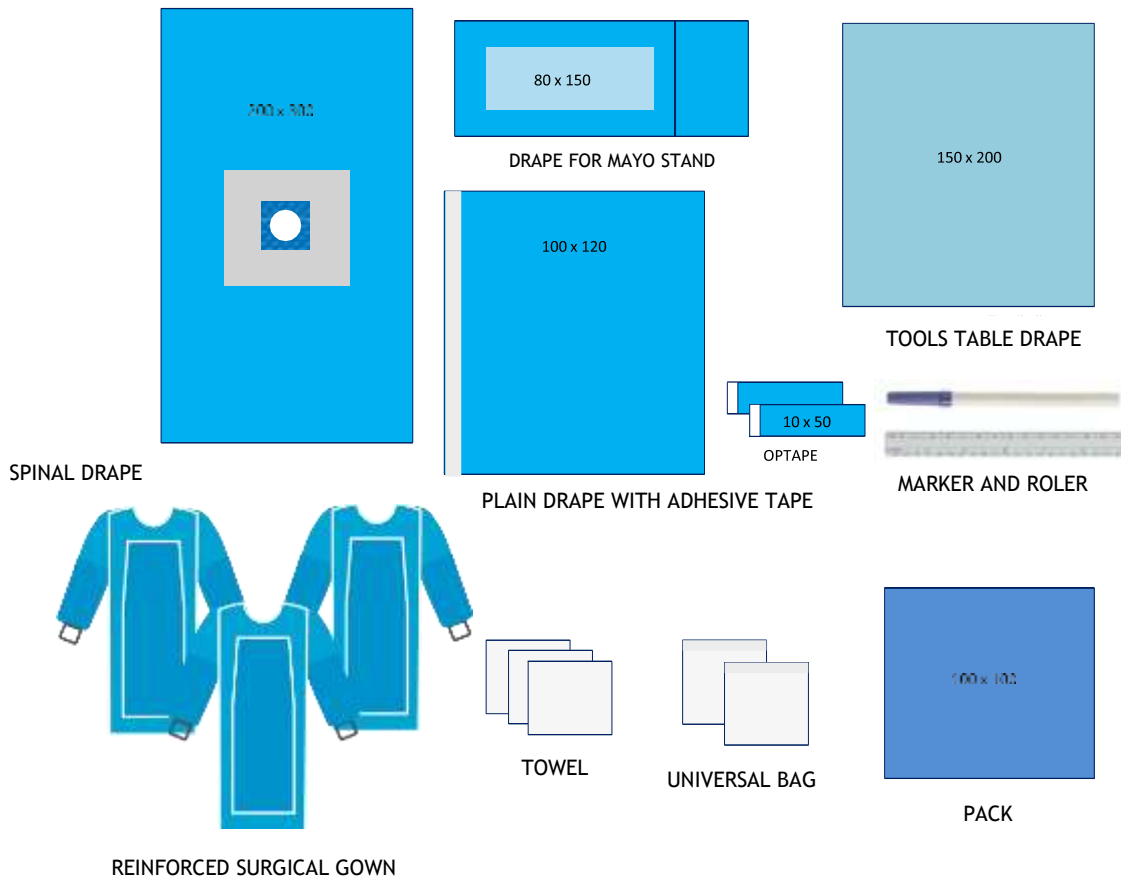

REF. MDC-ORTS-0093

	Sizes	Pieces
SPINAL DRAPE	200 X 300	1
TOOLS TABLE DRAPE	150 X 200	1
DRAPE FOR MAYO STAND	80 X 150	1
PLAIN DRAPE WITH ADHESIVE TAPE	100 X 120	2
OP-TAPE	10 X 50	2
MARKER AND ROLER		1
UNIVERSAL BAG	50 X 60	1
REINFORCED SURGICAL GOWN	L	3
TOWEL	40 X 40	3
PACK	100 x 100	1

Note: The set contents are for information purposes. The optional production can be done.



## Ophthalmologic Surgical Drape Sets



## Eye Drapes with Single Pouch

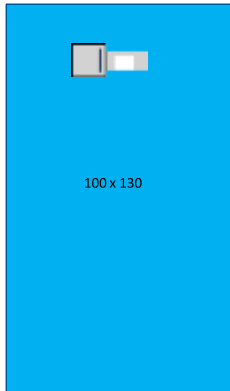

100 x 130

Eye Drape

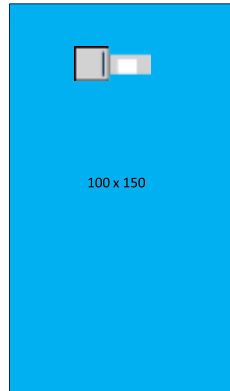

100 x 150

Eye Drape

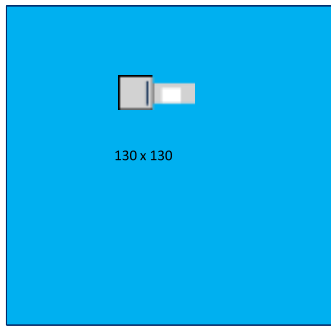

130 x 130

Eye Drape

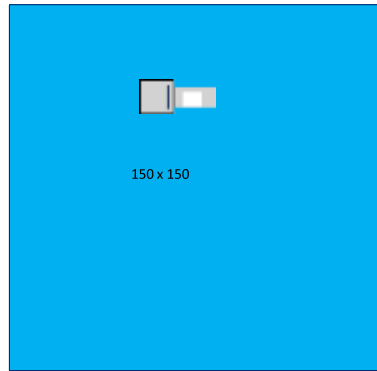

150 x 150

Eye Drape

**REF.** Section of Eye Drapes

EYE DRAPES WITH SINGLE POUCH		Sizes	Pieces
	EYE DRAPE	100 X 300	1
	EYE DRAPE	100 X 150	1
	EYE DRAPE	130 X 130	1
	EYE DRAPE	150 X 150	1

*Note: The set contents are for information purposes. The optional production can be done.*

## Eye Drapes with Double Pouch

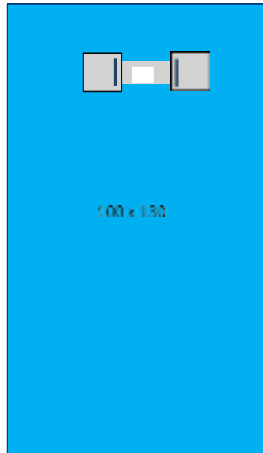

100 x 300

Eye Drape

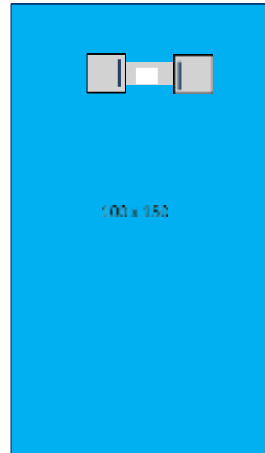

100 x 150

Eye Drape

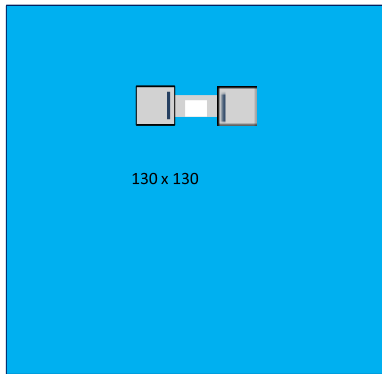

130 x 130

Eye Drape

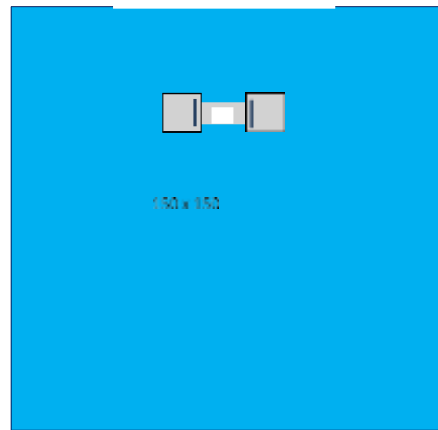

150 x 150

Eye Drape

**REF.** Section of Eye Drapes

EYE DRAPES WITH DOUBLE POUCH		Sizes	Pieces
	EYE DRAPE	100 X 300	1
	EYE DRAPE	100 X 150	1
	EYE DRAPE	130 X 130	1
	EYE DRAPE	150 X 150	1

Note: The set contents are for information purposes. The optional production can be done.

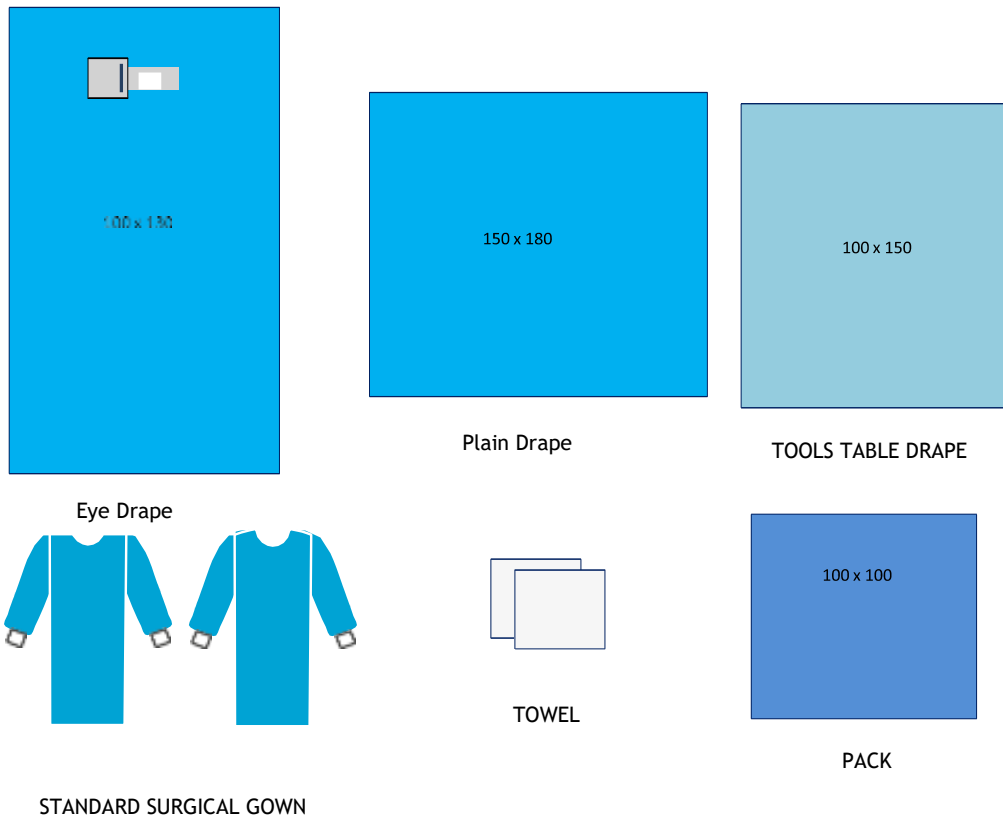

REF. MDC-ORTS-0265

EYE DRAPE SET		Sizes	Pieces
	EYE DRAPE WITH SINGLE POUCH	100 X 130	1
	PLAIN DRAPE	150 X 180	1
	TOOLS TABLE DRAPE	100 X 150	1
	STANDARD SURGICAL GOWN	L	2
	TOWEL	40 X 40	2
	PACK	100 X 100	1

Note: The set contents are for information purposes. The optional production can be done.

## Laser Eye Drape Set

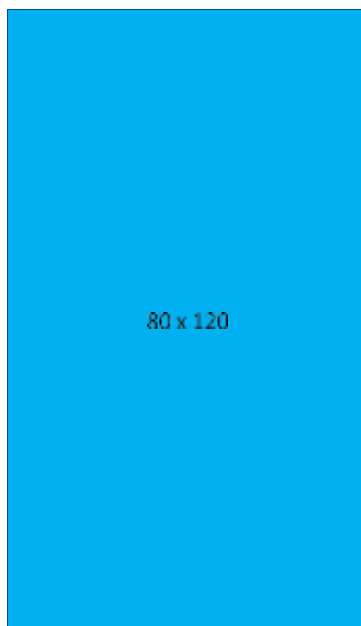

PE-NYLON

**REF.** MDC-ORTS-0883

		Sizes	Pieces
LASER EYE DRAPE SET	PE-NYLON	100 X 130	1

*Note: The set contents are for information purposes. The optional production can be done.*



Surgical Drape Sets for Oncology





## Chemotherapy Drape Set

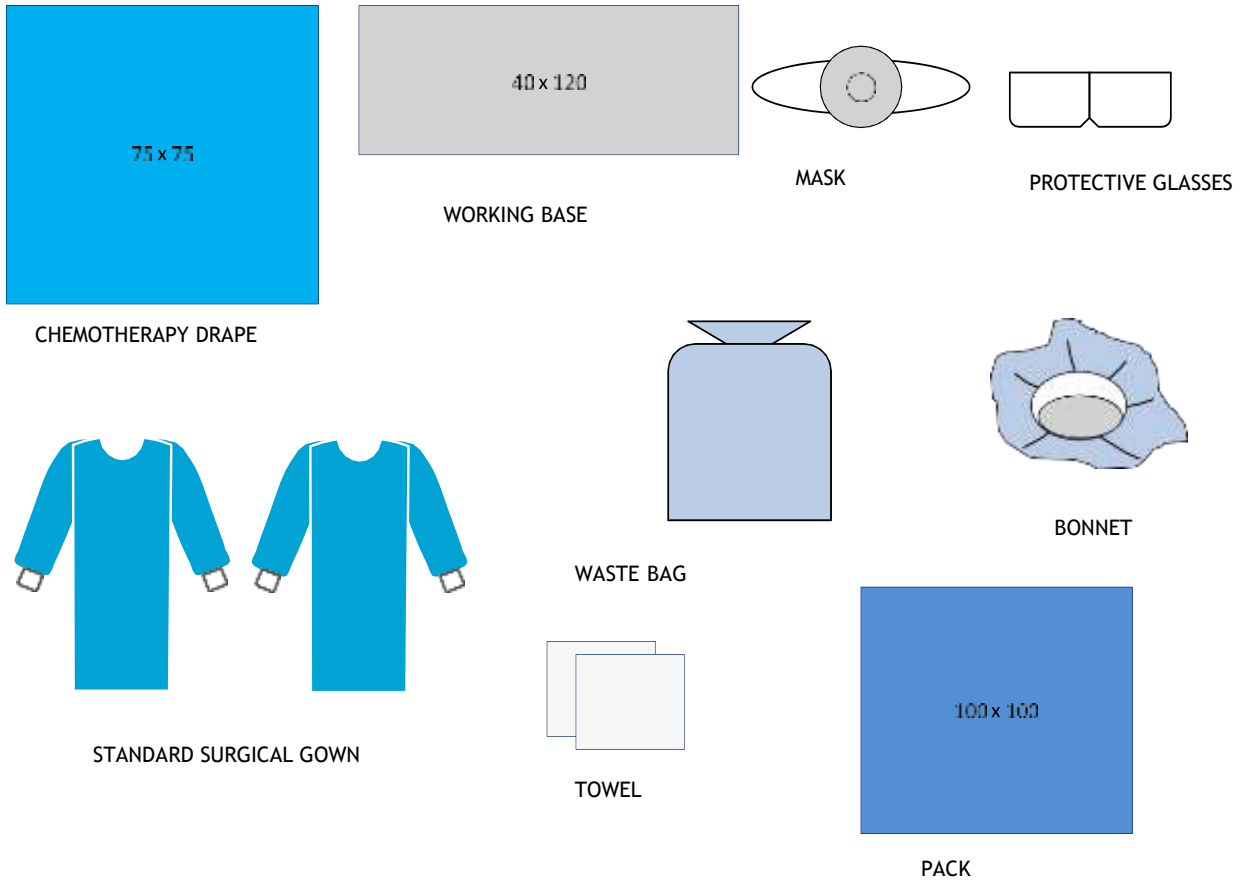

REF. MDC-ORTS-0353

CHEMOTHERAPY DRAPE SET		Sizes	Pieces
	CHEMOTHERAPY DRAPE	75 X 75	1
	WORK BASE	40 X 120	1
	MASK		1
	PROTECTIVE GLASSES		1
	BONNET		1
	CHEMOTHERAPY GLOVES	PAIR	1
	WASTE BAG		1
	STANDARD SURGICAL GOWN	L	2
	TOWEL	40 X 40	2
PACK	100 X 100	1	

Note: The set contents are for information purposes. The optional production can be done.



## Surgical Drape Sets for Urology



## Percutaneous Drape Set

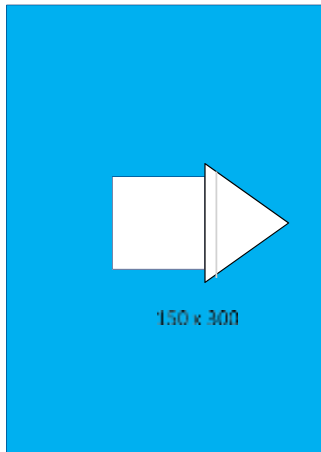

PERCUTANEOUS DRAPE



TOOLS TABLE DRAPE

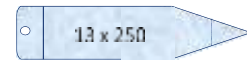

CAMERA COVER



OPTAPE



STANDARD SURGICAL GOWN



TOWEL



PACK

**REF. MDC-ORTS-0365**

PERCUTANEOUS DRAPE SET

	Sizes	Pieces
PERCUTANEOUS DRAPE	150 x 300	1
TOOLS TABLE DRAPE	100 X 150	1
OP-TAPE	10 X 50	1
FLUOROSCOPY COVER	50 X 80	1
CAMERA COVER	13 X 250	1
STANDARD SURGICAL GOWN	L	2
TOWEL	40 X 40	2
PACK	100 X 100	1

*Note: The set contents are for information purposes. The optional production can be done.*

## T. U. R. Drape Set

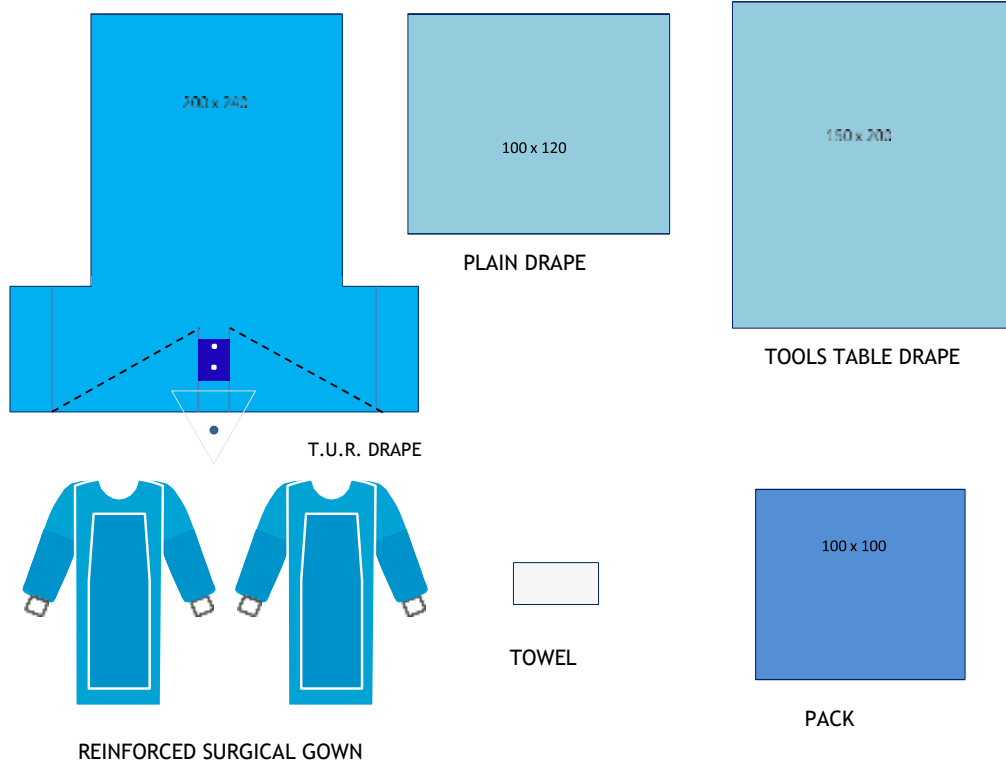

**REF. MDC-ORTS-0253**

### T.U.R. DRAPE SET

	Sizes	Pieces
T.U.R. DRAPE	200 X 240	1
PLAIN DRAPE	100 X 120	1
TOOLS TABLE DRAPE	150 X 200	1
REINFORCED SURGICAL GOWN	L	2
TOWEL	40 X 25	1
PACK	100 X 100	1

*Note: The set contents are for information purposes. The optional production can be done.*

## Cystoscopy Drape Set

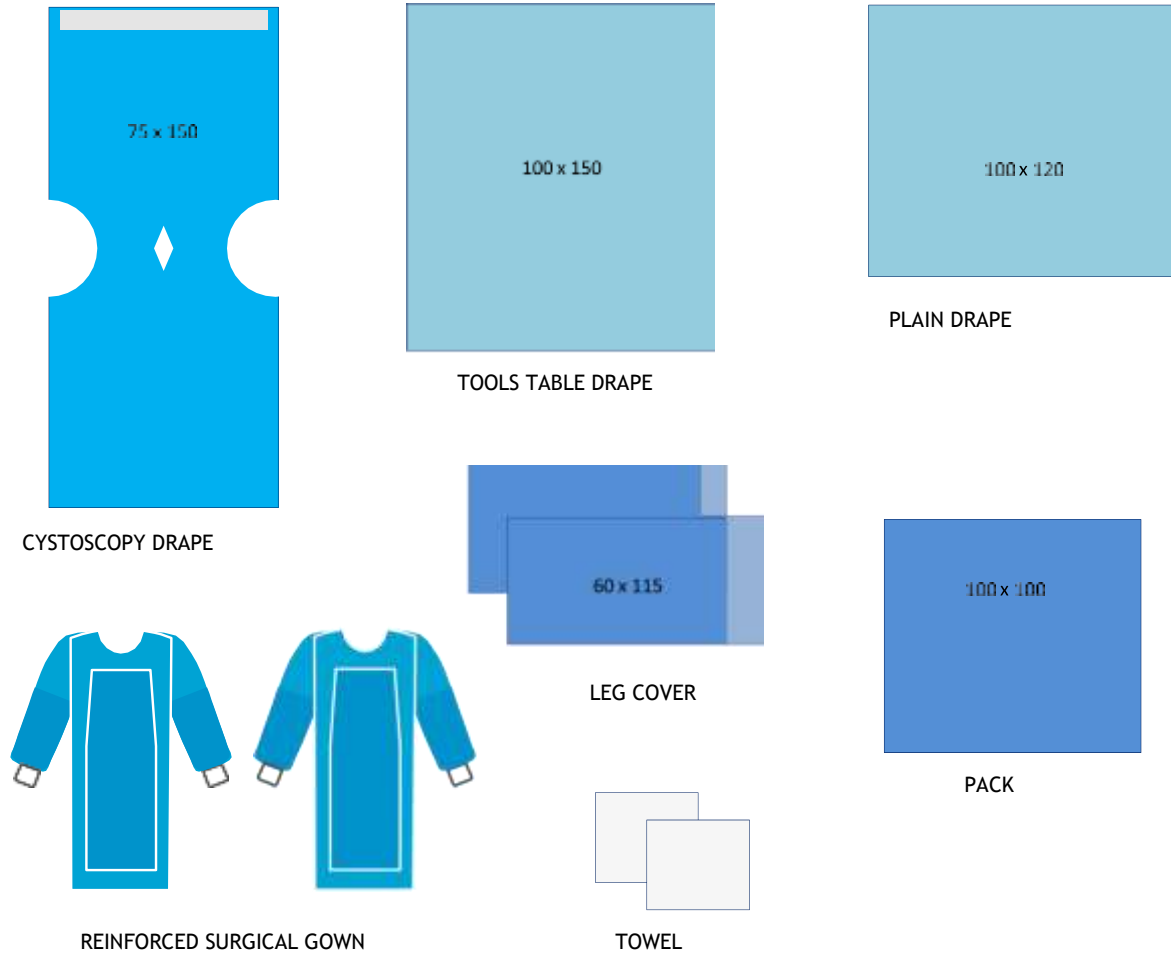

**REF. MDC-ORTS-0361**

### CYSTOSCOPY DRAPE SET

	Sizes	Pieces
CYSTOSCOPY DRAPE	75 x 150	1
PLAIN DRAPE	100 X 120	1
TOOLS TABLE DRAPE	100 X 150	1
LEG COVER	60 X 115	2
REINFORCED SURGICAL GOWN	L	2
TOWEL	40 X 40	1
PACK	100 X 100	1

*Note: The set contents are for information purposes. The optional production can be done.*

## Biopsy (TESE) Drape Set

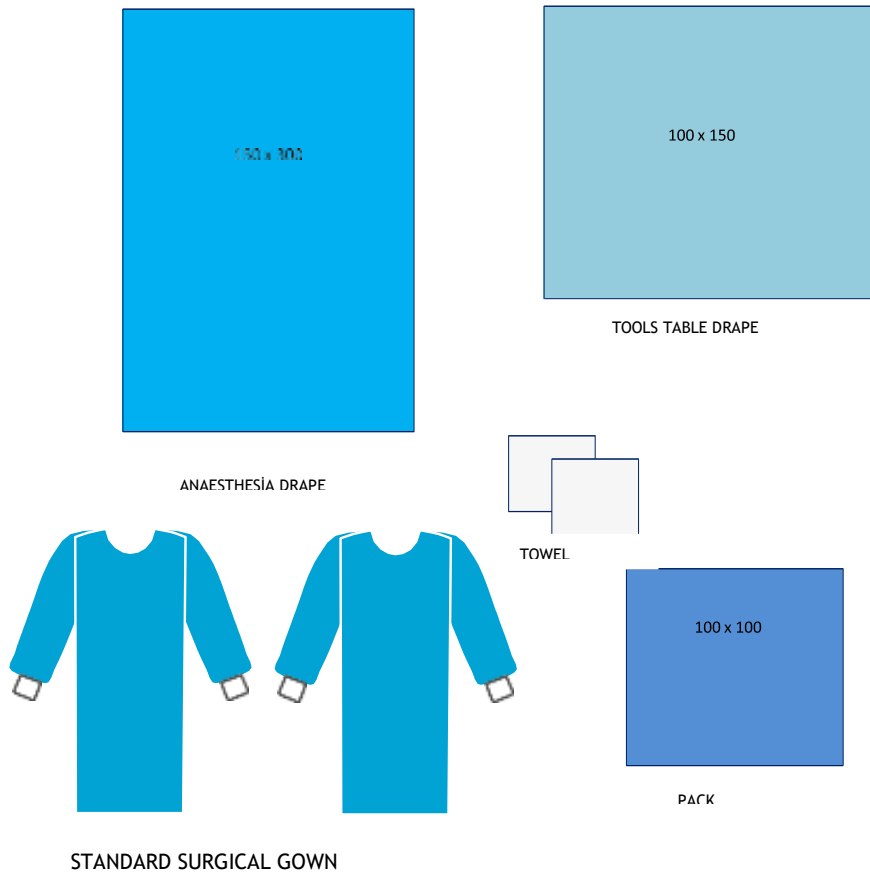

**REF. MDC-ORTS-0369**

### BIOPSY (TESE) DRAPE SET

	Sizes	Pieces
ANESTHESIA DRAPE	150 X 300	1
TOOLS TABLE DRAPE	100 X 150	1
STANDARD SURGICAL GOWN	L	2
TOWEL	40 X 40	2
PACK	75 X 75	1

*Note: The set contents are for information purposes. The optional production can be done.*



Surgical Drape Sets for E.N.T.



## E.N.T. Drape Set

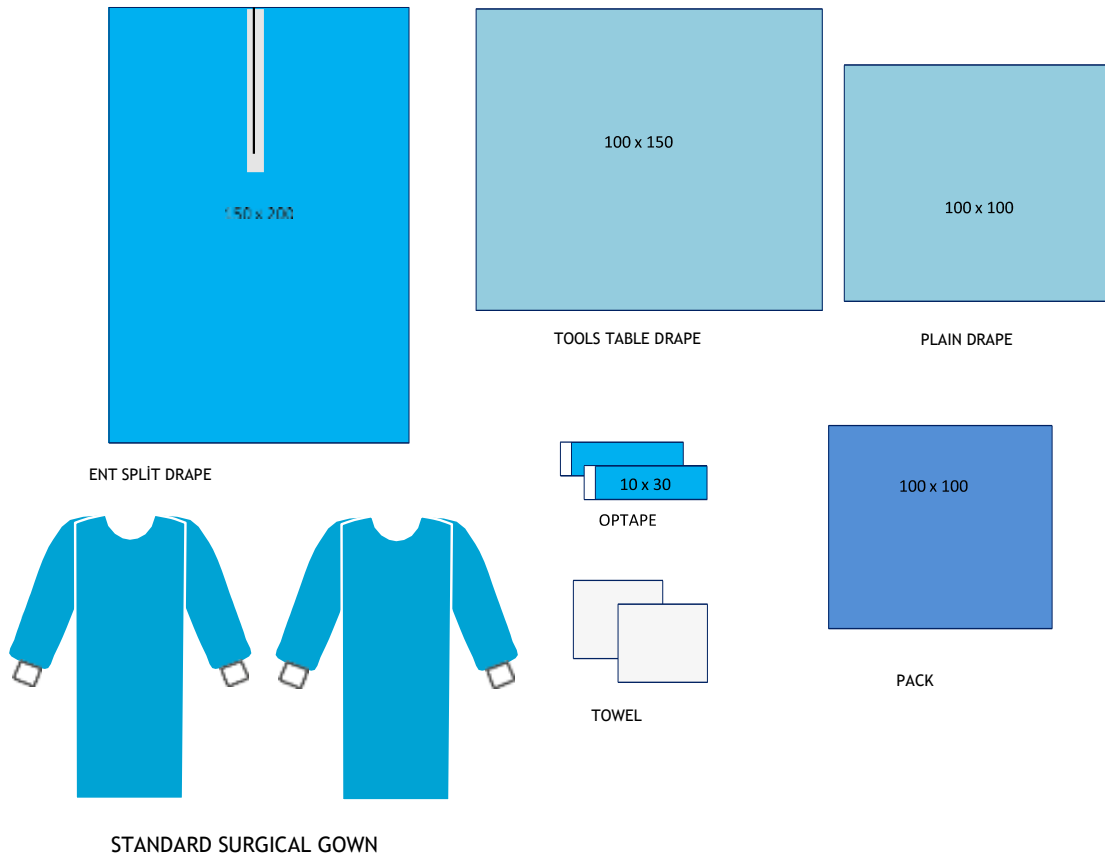

**REF. MDC-ORTS-0429**

### E.N.T. DRAPE SET

	Sizes	Pieces
E.N.T. SPLIT DRAPE	150 X 200	1
PLAIN DRAPE	100 X 100	1
TOOLS TABLE DRAPE	100 X 150	1
OP-TAPE	10 X 30	2
STANDARD SURGICAL GOWN	L	2
TOWEL	40 X 40	2
PACK	100 X 100	1

*Note: The set contents are for information purposes. The optional production can be done.*



## Thyroid Drape Set

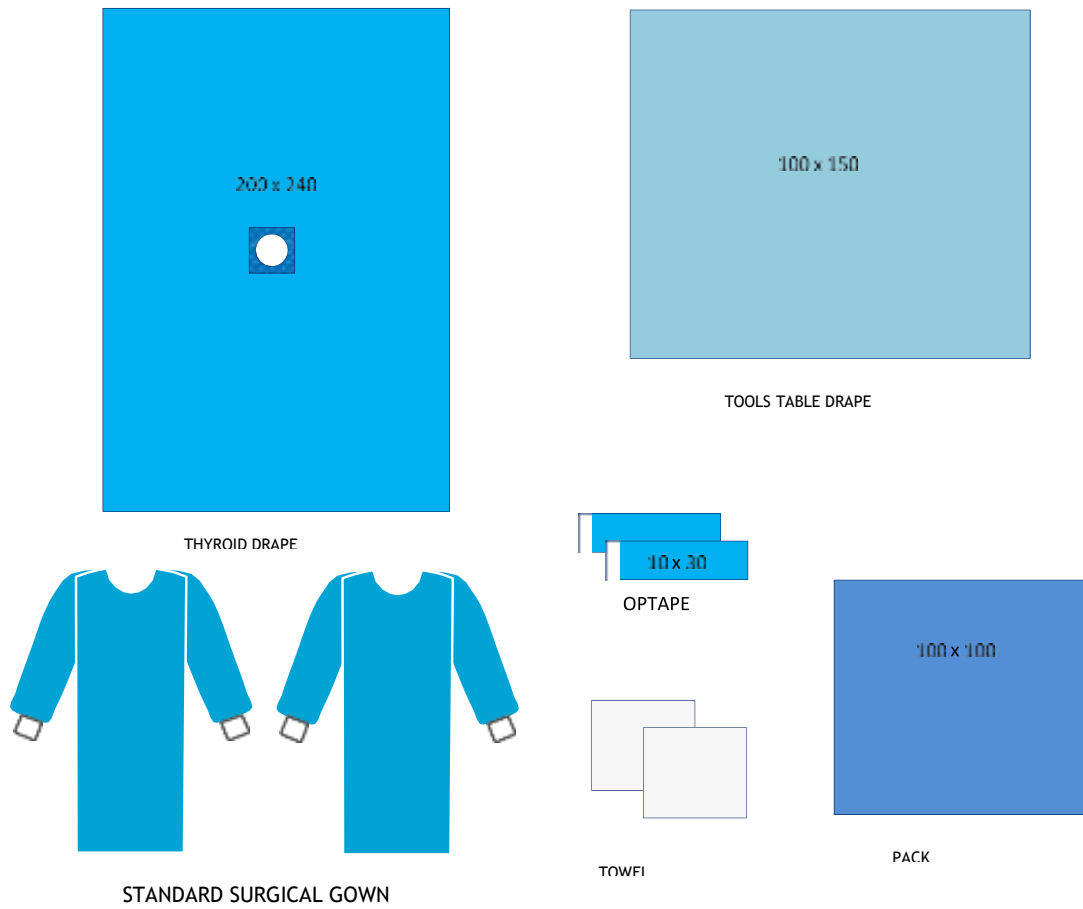

**REF. MDC-ORTS-0884**

### THYROID DRAPE SET

	Sizes	Pieces
THYROID DRAPE	200 X 240	1
TOOLS TABLE DRAPE	100 X 150	1
OP-TAPE	10 X 30	2
STANDARD SURGICAL GOWN	L	2
TOWEL	40 X 40	2
PACK	100 X 100	1

*Note: The set contents are for information purposes. The optional production can be done.*



Surgical Drape Sets for Aesthetics



## Rhinoplasty Drape Set

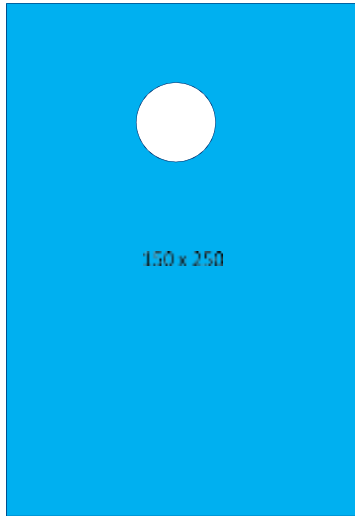

RHINOPLASTY DRAPE

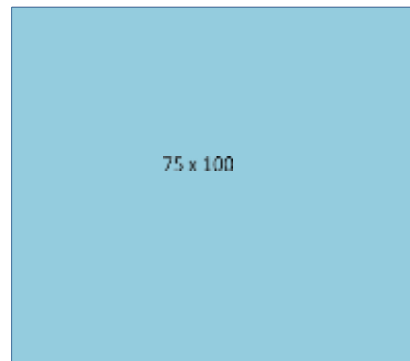

TOOLS TABLE DRAPE



DRAPE FOR MAYA STAND



STANDARD SURGICAL GOWN



TOWEL

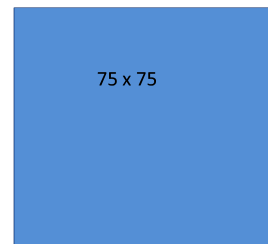

PACK

**REF. MDC-ORTS-0885**

RHINOPLASTY DRAPE SET

	Sizes	Pieces
RHINOPLASTY DRAPE	150 X 250	1
DRAPE FOR MAYO STAND	80 X 150	1
TOOLS TABLE DRAPE	75 X 100	2
STANDARD SURGICAL GOWN	L	1
TOWEL	40 X 40	1
PACK	75 X 75	1

*Note: The set contents are for information purposes. The optional production can be done.*

## Liposculpture Drape Set

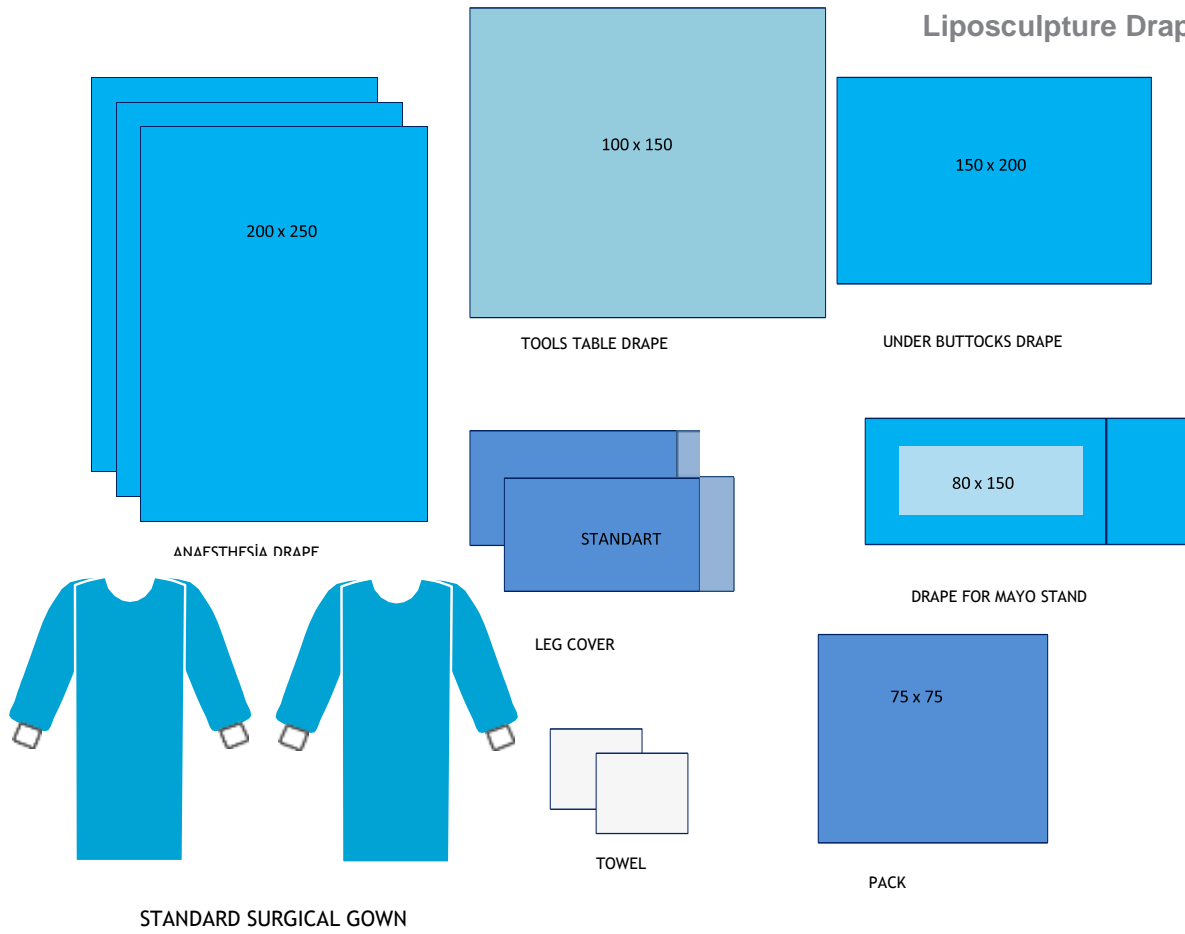

REF. MDC-ORTS-0886

### LIPOSCULPTURE DRAPE SET

	Sizes	Pieces
ANAESTHESIA DRAPE	200 X 250	3
UNDER BUTTOCKS DRAPE	150 X 200	1
DRAPE FOR MAYO STAND	80 X 150	1
TOOLS TABLE DRAPE	100 X 150	1
LEG COVR	STANDARD	2
STANDARD SURGICAL GOWN	L	2
TOWEL	40 X 40	2

Note: The set contents are for information purposes. The optional production can be done.



Drape Sets for Dental Surgery



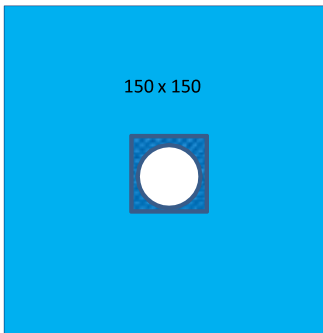

PATIENT DRAPE WITH HOLE

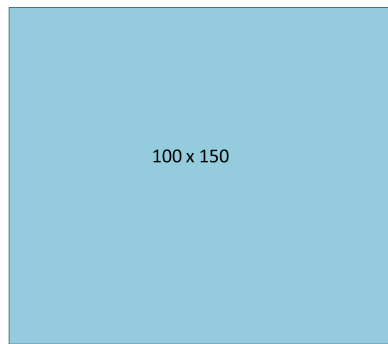

TOOLS TABLE DRAPE

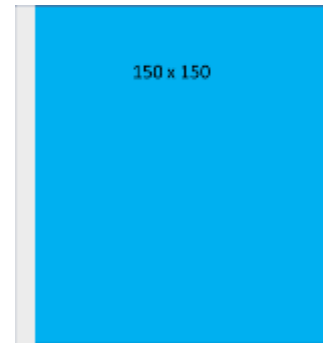

DRAPE WITH ADHESIVE TAPE



STANDARD SURGICAL GOWN

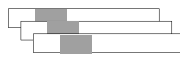

8 x 200

TRANSPARENT HOSE COVER

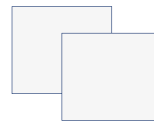

TOWEL

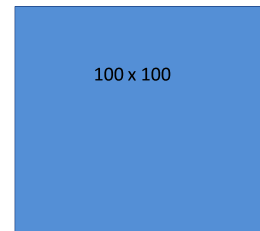

PACK

**REF. MDC-ORTS-0281**

DENTAL DRAPE SET

	Sizes	Pieces
PATIENT DRAPE WITH HOLE	150 X 150	1
DRAPE WITH ADHESIVE TAPE	150 X 150	1
TOOLS TABLE DRAPE	100 X 150	1
TRANSPARENT HOSE COVER	8 X 200	3
STANDARD SURGICAL GOWN	L	1
TOWEL	40 X 40	2
PACK OF STERILIZATION	100 X 100	1

*Note: The set contents are for information purposes. The optional production can be done.*

## Implant Drape Set

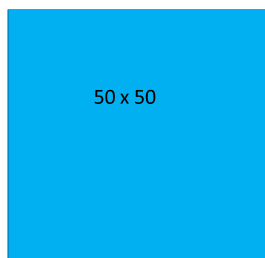
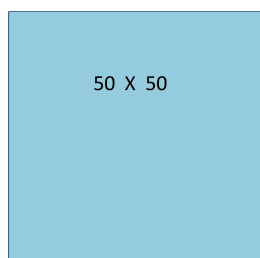
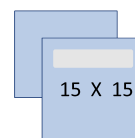

PLATE DRAPE



TOOLS TABLE DRAPE



REFLECTOR DRAPE

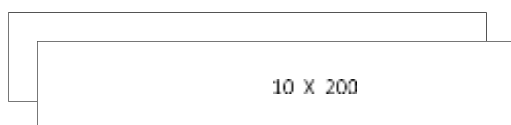

TRANSPARENT DRAPE



SPONGE



STANDARD SURGICAL GOWN



TOWEL

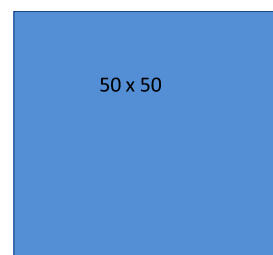

PACK

**REF. MDC-ORTS-0285**

IMPLANT DRAPE SET

	Sizes	Pieces
PLATE DRAPE	50 X 50	1
TOOLS TABLE DRAPE	100 X 150	1
SPONGE	7,5 x 7,5	10
TRANSPARENT DRAPE	10 X 200	2
REFLECTOR DRAPE	15 X 15	2
STANDARD SURGICAL GOWN	L	1
TOWEL	40 X 40	2
PACK OF STERILIZATION	50 X 50	1

*Note: The set contents are for information purposes. The optional production can be done.*



Disposable Clothing and Equipment





Disposable Clothing and Equipment



REF. NS-TUL-001



REF. NS-TUL-002



REF. NS-TUL-003



REF. NS-AO-001



REF. NS-KLN-0001



REF. NS-SED-0001





# AKMEDA MEDIKAL

Ostim OSB Mah. 1212 Cadde No: 2  
Yenimahalle / ANKARA / TÜRKİYE  
Tel: 0312 354 22 22 Fax: 0312 354 22 78

[info@akmeda.com](mailto:info@akmeda.com)

[www.akmeda.com](http://www.akmeda.com)